

# **Report ITU-R M.2533-0**

## **(09/2023)**

M Series: Mobile, radiodetermination, amateur  
and related satellite services

# **Utility radiocommunications operating in the land-mobile service**



## Foreword

The role of the Radiocommunication Sector is to ensure the rational, equitable, efficient and economical use of the radio-frequency spectrum by all radiocommunication services, including satellite services, and carry out studies without limit of frequency range on the basis of which Recommendations are adopted.

The regulatory and policy functions of the Radiocommunication Sector are performed by World and Regional Radiocommunication Conferences and Radiocommunication Assemblies supported by Study Groups.

## Policy on Intellectual Property Right (IPR)

ITU-R policy on IPR is described in the Common Patent Policy for ITU-T/ITU-R/ISO/IEC referenced in Resolution ITU-R 1. Forms to be used for the submission of patent statements and licensing declarations by patent holders are available from <http://www.itu.int/ITU-R/go/patents/en> where the Guidelines for Implementation of the Common Patent Policy for ITU-T/ITU-R/ISO/IEC and the ITU-R patent information database can also be found.

### Series of ITU-R Reports

(Also available online at <https://www.itu.int/publ/R-REP/en>)

Series	Title
BO	Satellite delivery
BR	Recording for production, archival and play-out; film for television
BS	Broadcasting service (sound)
BT	Broadcasting service (television)
F	Fixed service
<b>M</b>	<b>Mobile, radiodetermination, amateur and related satellite services</b>
P	Radiowave propagation
RA	Radio astronomy
RS	Remote sensing systems
S	Fixed-satellite service
SA	Space applications and meteorology
SF	Frequency sharing and coordination between fixed-satellite and fixed service systems
SM	Spectrum management
TF	Time signals and frequency standards emissions

*Note: This ITU-R Report was approved in English by the Study Group under the procedure detailed in Resolution ITU-R 1.*

*Electronic Publication  
Geneva, 2023*

© ITU 2023

All rights reserved. No part of this publication may be reproduced, by any means whatsoever, without written permission of ITU.

## REPORT ITU-R M.2533-0

**Utility radiocommunications operating in the land-mobile service**

(Question ITU-R 37-6/5)

(2023)

## TABLE OF CONTENTS

	<i>Page</i>
1	Scope ..... 5
2	Characteristics of utility communications systems ..... 5
2.1	Introduction..... 5
2.2	Communications objectives of smart grid communications technologies ..... 6
2.3	Operational objectives of utility radiocommunications systems for modern utilities ..... 9
3	Utilities integrated communications network architecture ..... 10
3.1	Traffic aggregation at network endpoints..... 12
3.2	Core network (WAN) ..... 12
3.3	Access networks (FANs) ..... 12
3.4	Evolution of substation LAN architecture ..... 13
4	Utility radio communications systems ..... 16
4.1	Overview..... 16
4.2	Grid modernization..... 17
4.3	The importance of wireless networks for utilities ..... 18
5	Spectrum related aspects ..... 19
5.1	Utility spectrum bands and applications..... 19
5.2	Spectrum bands used by utilities ..... 20
5.3	Suitable radio spectrum ..... 21
6	Societal importance of utility radiocommunications systems ..... 22
7	Summary..... 22
	Annex 1 – Digital transformation of energy networks ..... 24
1	Utility modernization/digital transformation..... 24
1.1	Electricity utility modernization ..... 24
1.2	Water and gas utilities digital transformation..... 24

2	Overview of smarter electricity networks .....	25
2.1	Opportunities and challenges with connected power distribution grids .....	27
3	Smart network applications and services.....	27
3.1	Supervisory Control And Data Acquisition (SCADA) .....	28
3.2	Advanced Metering Infrastructure (AMI) .....	28
3.3	Demand Response (DR) .....	29
3.4	Distribution Automation (DA) .....	29
3.5	Distributed Generation (DG) .....	30
3.6	Distributed Storage (DS) .....	30
3.7	Electric Vehicle Charging Stations (EVCS).....	31
3.8	Synchrophasors.....	31
3.9	Dynamic Line Rating (DLR) .....	31
3.10	Utility engineering and operations.....	31
3.11	Closed Circuit Television (CCTV).....	31
3.12	Mobile Workforce (MWF) .....	32
3.13	Protection applications.....	32
3.14	Digital Disturbance Recorder (DDR) .....	32
3.15	Precise load control.....	32
Annex 2 – General technical and operational characteristics of mission critical utility applications .....		33
1	Introduction .....	33
1.1	Protection applications.....	33
1.2	SCADA.....	34
1.3	Operational voice and data .....	35
1.4	Remote metering.....	36
1.5	Digital Disturbance Recorder (DDR) .....	37
2	Description of existing communications systems to support utility applications .....	38
Annex 3 – An overview of a smart water management system.....		40
1	Introduction .....	40
2	Smart water management components .....	40
2.1	Digital output instruments (meters and sensors) .....	40

2.2	Supervisory Control And Data Acquisition (SCADA) systems.....	40
2.3	Geographic information system (GIS).....	40
2.4	Application software.....	40
Annex 4 – Natural Gas example: An overview of transport, storage and distribution.....		41
1	Transmission pipes .....	42
2	Compressor stations.....	42
3	Metering stations .....	42
4	Valves .....	42
5	Control stations and SCADA Systems .....	43
6	Storage.....	43
7	Distribution.....	43
8	Delivery of natural gas .....	44
Annex 5 – Utility mission critical communication networks .....		44
1	Spectrum and climate change .....	44
2	Network characteristics .....	46
3	Utility Involvement in 3GPP .....	47
4	Societal Importance of the Utility Radiocommunications Systems .....	48
Annex 6 – National developments .....		49
1	Brazil .....	49
1.1	Background.....	49
1.2	Regulatory provisions governing the access of utilities to spectrum in Brazil...	51
2	China.....	55
3	Ireland.....	57
3.1	Case Study – Spectrum for the Smart Grid .....	57
3.2	Policy Issues and Objectives .....	57
3.3	What is required to deliver a Smart Grid? .....	58
3.4	Preferred Option.....	59
3.5	The Award of 400 MHz Rights of Use .....	59
3.6	References.....	63

4	Republic of Korea.....	62
5	United Kingdom of Great Britain and Northern Ireland .....	64
	5.1 Utility spectrum management.....	64
	5.2 Utility spectrum access .....	64
	5.3 Future utilities needs.....	64
6	France .....	67
	6.1 Utility spectrum management.....	67
	6.2 Transmission.....	67
	6.3 Generation.....	68
	6.4 Distribution .....	68
	6.5 Smart Meters.....	69
	6.6 Future spectrum options for utilities.....	69
	Annex 7 – Relevant ITU-R and ITU-T Resolutions, Recommendations, Reports and Handbooks.....	71
	List of definitions, acronyms and abbreviations .....	72

## 1 Scope

This Report describes radiocommunication systems and applications in the land mobile service that can be used by electric, gas and water utilities, and highlights how utilities can utilize these systems to support their needs for mobile voice and data communications as well as fixed wireless access.

Background information is provided in the Annexes on the operations and experiences of utilities that operate under the land mobile service in order to assist in understanding their communications needs.

## 2 Characteristics of utility communications systems

### 2.1 Introduction

Utilities involved in the generation, transmission and distribution of electricity, gas and water supplies, including wastewater management, need reliable and secure communications to operate efficiently the business-critical applications and improve workplace safety.

Utility systems are characterized by high reliability, high availability and low latency. Utilities typically operate their own operational communications networks in order to ensure communications reliability during extended power outages or other situations when public commercial communications networks may become adversely affected. This includes extended back-up power and diverse and redundant routing of backhaul communications networks at every wireless site. They also communicate in areas that commercial communications networks do not cover but where utilities may have critical assets, such as remote areas where generation or transmission infrastructure is located.

Utilities communicate with very low latency, depending on the type of utility application as low as 20 milliseconds or less. Some applications, such as protection and synchrophasors, need extremely low latency services to prevent faults on the grid from cascading and causing widespread outages and/or safety issues. Hence, utility communications networks can be characterized as highly reliable, available, and operate at low latency, as shown in Table 1.

TABLE 1

**Smart network communications parameter matrix**

Smart network sub-system	Coverage	Reliability	Latency time	Security
Meter reading – AMI	Medium	Medium	High	High
Field area network	High	High	Medium	High
Phase measurement	Medium	High	Low	Medium
Protection	Medium	High	Low	Medium

As utilities implement grid modernization more densely and deeper into their infrastructure, they are expected to need additional capacity and coverage as they shift towards two-way, real-time communications systems to provide increased control to turn systems on and turn off remotely, automatically and dynamically without the need to send out a truck and manually reclose circuits when breakers have tripped. Moreover, they will be able to automatically detect a power outage and restore power instantly by rerouting it, instead of having to attempt to triangulate a power outage based upon customer calls that a power outage has occurred and then sending a truck into the area to determine the exact location where a tree has fallen across a line or a transformer has failed. All of this automation would benefit from additional capacity and coverage in utility communications systems.

### 2.1.1 Electricity utilities

In general, an electricity network or electricity grid is a network for distributing electrical energy from producers to consumers. It consists of:

- generating stations that produce electric power;
- electrical substations for stepping electrical voltage up for transmission, or down for distribution;
- high voltage transmission lines that carry power from distant energy sources to demand-centres;
- distribution lines that connect to individual customers.

Many traditional electricity networks are not smart enough to meet today's requirements. A smart grid is an electricity network that enables a two-way flow of electricity and data.

Annex 1 contains a description of the digital transformation of energy networks, generally referred to as smart grid or grid modernization.

### 2.1.2 Water utilities

In many countries water utilities manage the transmission of water from water sources to treatment plants and to consumers and industry. A water supply system consists of:

- Water collection sources such as a lake, river, a dam, or groundwater from underground aquifers.
- Transmission network of aqueducts covered tunnels or underground water pipes to transfer water to water treatment plants; underground pipes to carry treated water to water storage; and a pipe network for distribution to residential consumers and industry.
- Water treatment plants. Treated water is transferred using water pipes (usually underground).
- Water storage facilities such as reservoirs, water tanks, or water towers.
- Additional water pressurizing components such as pumping stations may need to be situated at the outlet of underground or above ground reservoirs or cisterns (if gravity flow is impractical).
- Connections to wastewater or sewers are generally found downstream of the water consumers.
- Wastewater treatment could be part of the services that water utilities provide and includes collection and treatment of waste and rainwater, processing and redistribution.

Annex 3 contains an overview of a smart water management system.

### 2.1.3 Gas utilities

The operations of gas utilities are, in some ways, similar to water utilities. Natural gas is transported from collection (storage) points at high pressure through (transmission) pipelines to local distribution networks of smaller diameter pipelines, at lower pressure, to end users such as residential homes, offices, restaurants and factories.

Annex 4 contains an overview of an example in the transport, storage and distribution of natural gas in North America.

## 2.2 Communications objectives of smart grid communications technologies

The following Tables list the various different utility applications and provide the requirements for latency as well as their relative priority. For example, protection applications, such as breaker reclosers and PMUs, which have extremely low latency and relatively high priority objectives, cannot



generally be reliably supported using commercial wireless broadband networks. However, advanced metering and some monitoring applications, such as AMI periodic measurements and fault recordings, could potentially be supported over existing commercial networks<sup>1</sup>.

TABLE 2  
Application latency objectives

Application	Minimum delay allowance (ms)	Priority: 0 = Max to 100 = Min
<b>Delay ≤ 10 ms</b>		
(High speed) Protection information	8, 10	2
Load shedding for under frequency (under 50-60 Hz)	10	20
<b>10 ms &lt; Delay ≤ 20 ms</b>		
Breaker reclosures	16	15
Lockout functions	16	12
Many transformer protection and ctrl Apps	16	12
System protection (PMU)	20	12
<b>20 ms &lt; Delay ≤ 100 ms</b>		
Synchrophasor measurements (Class A)	60	10
SCADA data poll response	100	25
PTT signalling (critical)	100	30
PMU clock synchronization	100	20
<b>100 ms &lt; Delay ≤ 250 ms</b>		
VoIP bearer (inc. PTT)	175	50
VoIP signalling (inc. PTT – normal)	200	60
Dynamic line rating (DLR)	200	40
Real-time video (mobile WF)	200	55
On Demand CCTV video	200	55
Other SCADA operation	200	45
Enterprise data – Preferred	250	70
Most distribution and SCADA Apps.	250	65
AMI – Critical	250	60

Traffic for these applications is only between two substations connected with transmission lines. This traffic should be designed to be only single hop. Thus, the corresponding delay objectives must be considered only single hop. All other delay objectives may have to be satisfied over multiple network hops.

<sup>1</sup> Field Area Networks, Utilities Telecom Council and Edison Electric Institute (Jan. 2014).

TABLE 3  
Application latency objectives (*cont.*)

Application	Minimum delay allowance (ms)	Priority: 0=Max to 100=Min
<b>250 ms &lt; Delay ≤ 1 s</b>		
AMI – priority	300	70
CCTV stream – normal	400	75
PMU (Class C)	500	80
Some transformer protection & ctrl apps	500	80
Enterprise data – other	500	80
<b>1 s &lt; Delay</b>		
Image files	1 000	90
Fault recorders	1 000	90
(Medium speed) monitoring and ctrl info	1 000	90
(Low speed) O&M info	1 000	90
Fault isolation and service restoration	1 000	90
Distribution applications	1 000	90
AMI periodic measurements	1 000	85
Text strings	1 000	90
Audio and video data streams	1 000	78
Fault recorders	1 000	90
Best effort, default	2 000	100

Ensuring that these systems are secure and can be delivered in a cost-effective way is a high priority within the industry.

Finally, some of the key characteristics the operational communications components of utility networks are highly ruggedized for extreme conditions within the substation environment and have traditionally used extended depreciation cycles; so that the equipment must last for an extended period of time.

These key characteristics to maintain utility networks and their functions are detailed in Table 4 below.

TABLE 4  
Network characteristics<sup>2</sup>

Application	Bandwidth	Latency	Reliability	Security	Backup power
AMI	10-100 kbit/s/node, 500 kbit/s for backhaul	2-15 s	99-99.99%	High	Not necessary
Demand response	14 kbit/s – 100 kbit/s per node/device	500 ms-several minutes	99-99.99%	High	Not necessary
Wide area situational awareness	600-1 500 kbit/s	20 ms-200 ms	99.999-99.9999%	High	24-hour supply
Distribution energy resources and storage	9.6-56 kbit/s	20 ms-15 s	99-99.99%	High	1 hour
Electric transportation	9.6-56 kbit/s, 100 kbit/s is a good target	2 s-5 min	99-99.99%	Relatively high	Not necessary
Distribution grid management	9.6-100 kbit/s	100 ms-2 s	99-99.999%	High	24-72 hours

Getting the data from field devices to the electric utility's back-office system, or getting commands to devices from back office systems, relies upon a secure, reliable network covering a geographical footprint that can vary from dense urban areas to remote locations with virtually no population. This data is often critical in managing the power system.

Simultaneously being able to respond to events via central commands adds to the complexity needed to manage the communications network. Thus, the network needs to be able to support the increased bandwidth requirements, as well as ongoing wide-area coverage and low-latency communications requirements necessary to effectively monitor and control operations.

### 2.3 Operational objectives of utility radiocommunications for modern utilities

Since the 1950s, utilities have been using telecommunications to monitor and control their electricity, water and gas networks.

Electricity is at the top of essential services list to society, whose unavailability or even temporary interruption can negatively affect the whole chain of other public services that are also essential to society, such as transportation, health, banking and telecommunications.

In 2010, the United States Department of Energy published a report entitled "Communications Requirements of Smart Grid Technologies"<sup>3</sup>, which identified six key communications priorities for modern utilities, including (1) advanced metering infrastructure; (2) demand response; (3) electric

<sup>2</sup> *Telecommunication Networks for the Smart Grid* (2016), Alberto Sendin, Miguel A. Sanchez-Fornie, Inigo Berganza, Javier Simon, Iker Urrutia, Artech House.

<sup>3</sup> Communications Requirements of Smart Grid Technologies, Department of Energy (Oct. 5, 2010), available at <https://www.energy.gov/gc/articles/communications-requirements-smart-grid-technologies>.

vehicles; (4) wide-area situational awareness; (5) distributed energy resources and storage; and, (6) distribution grid management. In addition, utilities face increasing communications needs to address physical and cybersecurity threats as well as extreme weather events and other natural disasters, such as hurricanes, tornados, and wildfires, which requires communications for a variety of utility applications including unmanned aircraft systems (UAS), Advanced Distribution Management Systems (ADMS), Fault Location Isolation and Service Restoration (FLISR), and Falling Line Conductor Detection systems generally. As more fully described herein, modern utilities need access to additional spectrum to meet these increasing communications needs.

The chain that forms the electricity system is composed of three important sectors: generation, transmission and distribution. These segments operate in an integrated way, being extremely important the management, control, automation and monitoring of the events resulting from human actions and nature that constantly impact the electrical system.

The electrical utilities networks “intelligence” is mainly based on the exchange of real-time information on measurement, supervision and control data, installed in their strategic positions in generation, transmission and distribution networks, as well as in homes, offices, companies, with the purpose of making it capable of automatically detecting, analysing, responding and restoring faults in the network, reducing interruption times, improving energy efficiency and reducing technical losses, in order to ensure the quality of services to be provided to society.

Utilities around the world use radiocommunications networks in their operations to support the safe, secure and reliable delivery of essential electric, gas and water services to the public at large. Such operational radiocommunications networks facilitate utility networks and are desired to be resilient with low latency to enable the use of certain utility applications.

Utilities use wireless technologies, for voice, control and data communications to support the operation of their critical systems. However, as described more in detail below, a wireless solution would need to support the ever-growing demand for the utilities services and certain performance characteristics associated with utility’s system availability, operation and management (e.g. performance requirements for smart grids).

Non-wireless telecommunications alternatives may be impractical for many applications that would need wide service area coverage and low-cost implementation. For example, it is usually difficult to enable fibre and wired technologies for millions of smart grid devices, many of which may be located in remote and otherwise inaccessible areas across the wide service area of a utility.

Suitable communications technologies can enable more efficient management and control of the flow of energy onto the distribution infrastructure. Some utilities are also implementing newer distribution automation technologies thereby enabling utilities to maintain power resilience and restore power more quickly after an outage and protect the utilities’ critical assets against physical and cyber-attacks. These are just some of the utility applications that are creating additional demand for new wireless communications capacity and coverage.

### **3 Utilities integrated communications network architecture**

Currently, communication network needs for most utilities are supported by disparate networks, each supporting a utility application such as SCADA, physical security (CCTV), or mobile workforce communication. With smarter electricity network evolution as well as the expected growth with a large number of new applications supporting a large number of endpoints, creation of a purpose-built network for each application cannot be sustained. It is extremely important that the utility ICT needs including that of connectivity to distributed generation are supported by an integrated network.

There is literature covering the most suitable elements to achieve a telecommunication network and service architecture that can make the Smart Grid become real. By way of example, the publication

Communication Networks for Smart Grids: Making Smart Grid Real (2014)<sup>4</sup>, provides a selection of telecommunications components; and the publication Telecommunication Networks for the Smart Grid (2016)<sup>5</sup> proposes a practical reference architecture that holds the value of having been deployed on the field. A practical, flexible and scalable target communication network architecture supporting all smarter electricity network applications is illustrated in Fig. 1.

Internet Protocol (IP) is assumed to be the underlying network protocol for the integrated network with support for connecting legacy endpoints and protocols (such as Time division multiplex (TDM)) using tunnels, circuit emulation, and/or gateways.

Given the expanse of the utility service territory, the number of endpoints that need to be connected into the network, and since communications for most applications are predominantly between sensors and/or remote endpoints and the central application control or processing servers, an edge-core network architecture is preferred as illustrated in Fig. 1. Another important aspect of this architecture is traffic aggregation at intermediate points in the network rather than direct communication between the endpoints, thus facilitating ease of traffic routing, reliability, QoS implementation and reduced costs.

To avoid complexity in the figure, not every possible application or network connectivity option is included in Fig. 1. In any case, the actual physical connections will be dictated by network design.

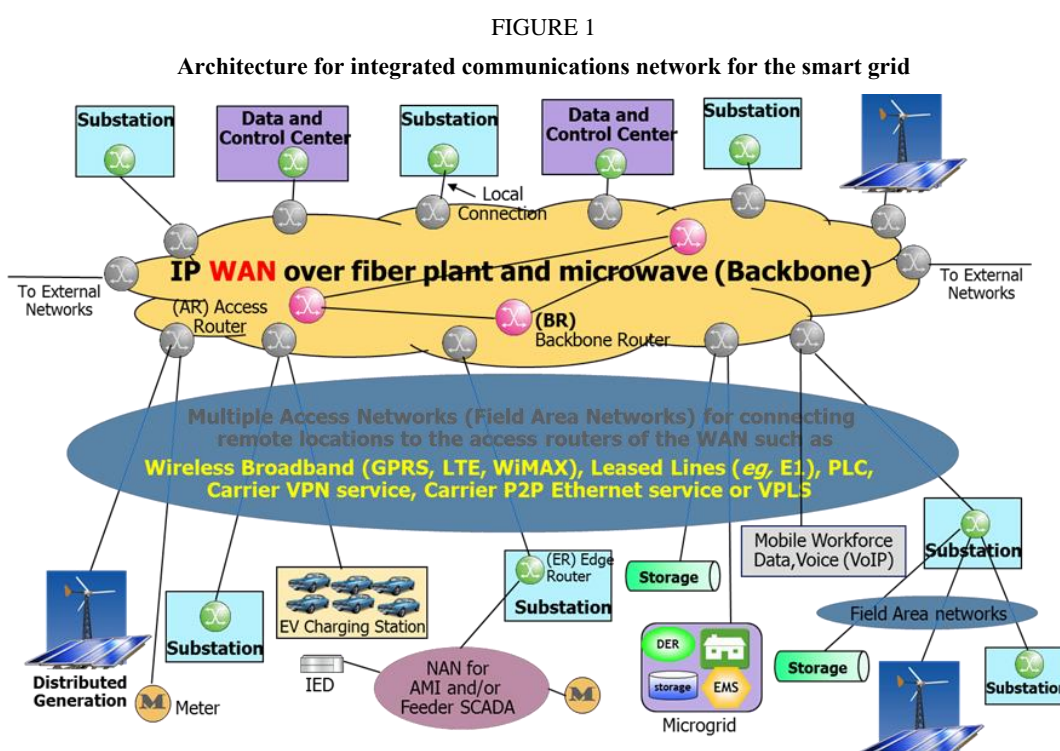

While the enterprise voice and data applications or utility enterprise offices are not included in Fig. 1, they can be easily supported by the architecture based on a utility's preference about integrating the OpTel and business applications on the same network.

<sup>4</sup> *Communication Networks for Smart Grids: Making Smart Grid Real* (2014), Kenneth C. Budka, Jayant G. Deshpande, Marina Thottan, Springer.

<sup>5</sup> *Telecommunication Networks for the Smart Grid* (2016), Alberto Sendin, Miguel A. Sanchez-Fornie, Inigo Berganza, Javier Simon, Iker Urrutia, Artech House.

### 3.1 Traffic aggregation at network endpoints

An Edge Router (ER) at an endpoint location aggregates traffic from multiple sources and applications at that location. For a location with a single endpoint or only a few endpoints, there may not be an ER at that location that aggregates their traffic and these endpoints may be connected directly into the network. Depending on network design, an ER may also be used to aggregate traffic from other locations in the vicinity. For example, an ER at a (large) substation may aggregate traffic from other (smaller) substations as well as traffic from other locations in the vicinity, in addition to the traffic generated at that substation itself.

### 3.2 Core network (WAN)

Depending on the network expanse and end points, the core network (sometimes called WAN – Wide Area Network) may vary from a single router up to a mesh of (redundant) interconnection of backbone routers (BR) and access routers (AR). Edge Routers not connected to other ERs and end points not connected to an ER connect to the ARs for network connectivity. Based on the reliability requirement, an end point (such as the data and control centre or a “important” substation may connect to two different access routers. An AR aggregates traffic to/from the end points that connect to the ARs, possibly through the ERs. The WAN must be a reliable network with very high reliability (e.g. there must be at least two physical paths between every pair of ARs). For that purpose, additional routers BRs may be deployed in the core network based on the network design.

Often the core network will be close to the utility data and control centres as well as to the substations in metro areas. Thus, some of the ARs may be collocated with these utility sites. For such a collocated site, its end points may connect to the corresponding AR over the LAN in that site. If required for redundancy, an ER at this site may additionally connect to an AR at another location over a FAN.

Based on security policies and security designs, firewalls and IDS/IPS systems are deployed at ARs and BRs.

In many cases the WAN will be owned and operated by the utility but that may not always be the case. Even the utility-owned WAN may lease or share basic physical resources such as fibre plants and spectrum.

Optical fibre is used extensively in the majority of Europe’s transmission system operator (TSO) companies. However due to the fact that they link the main electricity generators with the consumers centres, their capacity to contribute to distributed generation in medium voltage networks is limited.

However, not as many distribution system operators (DSOs), mainly in Western Europe, have any substantial amount of optical fibre. Nevertheless, most of them think they will need to install in the future as smart grids deploy, mainly in medium voltage networks. This will contribute to the deployment of highly reliable, cost efficient and secure networks.

### 3.3 Access networks (FANs)

Access networks (often called Field Area Networks – FANs) provide connections between utility locations and the ARs. After presenting a brief overview of the wireline and wireless FANs, we present a few more details on the Power Line Communication (PLC) technology which is being increasingly used in smart metering access and being explored for deployment in FANs including connectivity to DG.

The utility may use multiple wireline and wireless technologies for FANs. The FANs may be owned and operated by the utility (self-provided) or service provider networks may be used as FANs. Wireline technologies may include PLC, private lines, Layer 2 technologies as Ethernet and Frame Relay, and MPLS, VPLS or VPN service. The wireless broadband technologies may include 2G and 3G 3GPP technologies (e.g. GPRS and HSPA) with a migration path to 4G (e.g. LTE and WiMAX).

In parallel to this activity, European utilities in particular had identified some specific limitations of products based on the existing LTE standard to satisfy some of their specific technical requirements (e.g. latency, prioritization, power autonomy). As a result of concerted effort from EUTC, UTCAL and major utilities operators, a specific work item has been approved in 3GPP SA1 (approved July 2020). The intention of this work item is to drive development of utility specific functionality in future releases of the LTE 4G (IMT-2020) standard (from release 18 onwards). The initiatives are supported by almost 20 global organisations from the vendor, operator and end user community.

The mix of utility-owned and service provider network FANs depends on the service level agreements (SLA) provided by the service provider networks consistent with utility requirements, networking technology availability in an area, costs and other considerations. The choice of FAN technologies and ownership mix can evolve over time depending on the emergence of new technologies, utility access to spectrum, and network expansion with new applications and endpoint.

While strictly not FANs, and based on AMI communication technology, local Neighbourhood Area Networks (NAN) such as over license-exempt spectrum or over PLC may be used for concentrating smart meter traffic at substations or near distribution transformers. The NANs may also be used for concentrating the SCADA traffic from the IED deployed over feeders to RTU/IED in the substation. Note that meters and feeder IEDs may also directly connect to the ARs, depending on the vendor product communication technologies.

### **3.4 Evolution of substation LAN architecture**

Currently communication within most substations is limited to SCADA. IEDs and RTUs in the substation use point-to-point communication between them, often through a “data concentrator”. Most protocols are proprietary. The SCADA communication link between the substation and the SCADA control centre are often point to point TDM connections. If there are other applications located at the substations (such as protection, synchrophasors, and CCTV), they each have a separate communication links to their respective counterparts.

The substation LAN evolution will be on two different levels. At one level, the substation architecture of the utility operations applications such as SCADA and protection will evolve to the architecture specified in IEC 61850 standard. On another level, traffic generated by many new smart grid and other applications that will be resident at the substation such as the meter concentrators and CCTV will be aggregated at the substation router along with the SCADA and other operations traffic. The substation router is an ER in our integrated architecture of Fig. 2. The router at a (large) substation may additionally aggregate traffic generated in the vicinity of the substation.

FIGURE 2

## Evolution of substation architecture based on IEC 61850 standards

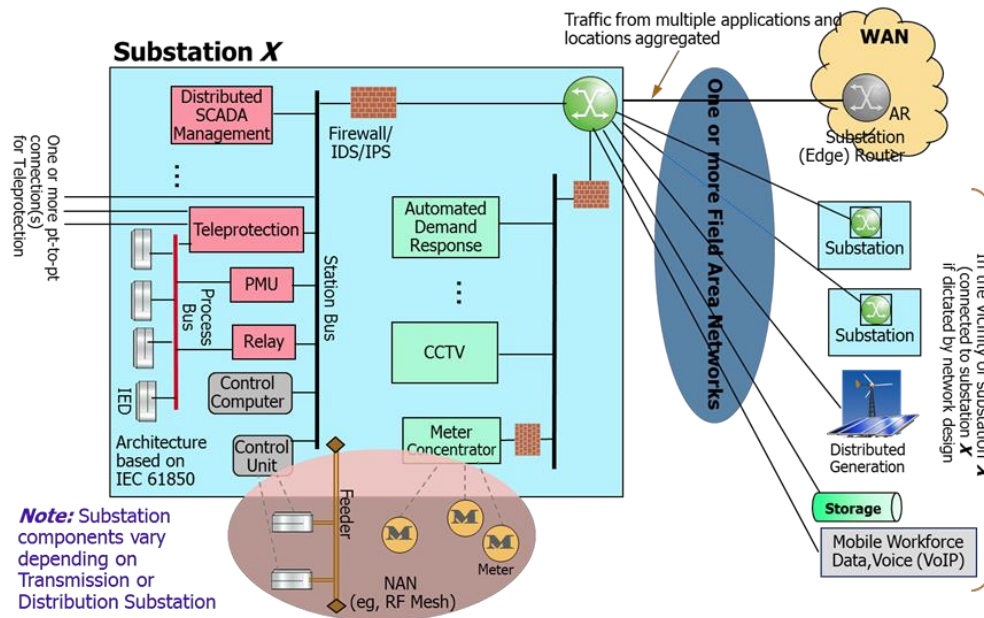

IEC 61850 defines a *process bus* that is an Ethernet bus. All SCADA IEDs and optionally the protection IEDs and PMUs connect to the process bus. For legacy equipment gateways may be used to connect into the process bus. There may be more than one process bus.

The *station bus* is used to connect the process busses as well as other operation systems such as the distribution automation traffic concentration from the feeder IEDs (if thus designed).

Access to all these operation elements is protected by protecting the station bus behind firewall and/or Intrusion detection and protection (IDS/IPS) systems.

The substation may use another Ethernet network for connecting other smart grid and utility systems such as the CCTV, meter concentrators, and demand response systems; access to these systems is protected by another firewall and/or IDS/IPS system.

Finally, the substation router aggregates all traffic generated at the substation and possibly traffic generated at (smaller) substations in the vicinity as well as traffic from other endpoints in the vicinity, examples of which are shown in Fig. 2.

Note that the utility may continue to use its existing TDM networks and/or possibly Ethernet connections for the protection traffic. The protection traffic may not be carried over the IP network for a period of time.

Connectivity to home area networks (HAN) is an important aspect of smart electricity network evolution in actively incorporating the consumer in energy management. Depending on the utility policies, the home networks *may* be allowed to be a part of the utility's integrated communication networks either with the connection through the smart meter or through a "home gateway".

Utilities are implementing new systems to automate operations and enhance their monitoring and control capabilities. These systems support a variety of applications, including advanced metering, demand response, distribution automation, and wide area measurement, protection and control (WAMPC). Overall, these systems will improve operational efficiency, safety and reliability by extending communications further into the distribution network and improving their performance.

The network architectures for these systems are varied. Some utilities deploy networks using centralized network architecture, such as point-to-multipoint networks; while others rely on decentralized network architecture, such as mesh networks. There are also hybrid networks that



include combinations of network architectures, as well. The FAN is expected to bridge the backhaul network to the field devices.

Figure 3 shows a combination of networks in a suburban configuration. A utility must manage the spectrum aspects of its applications across the entire geographic footprint and account for the different device densities, geography, zoning regulations, and other technical and non-technical limitations.

FIGURE 3  
Networks in a suburban configuration

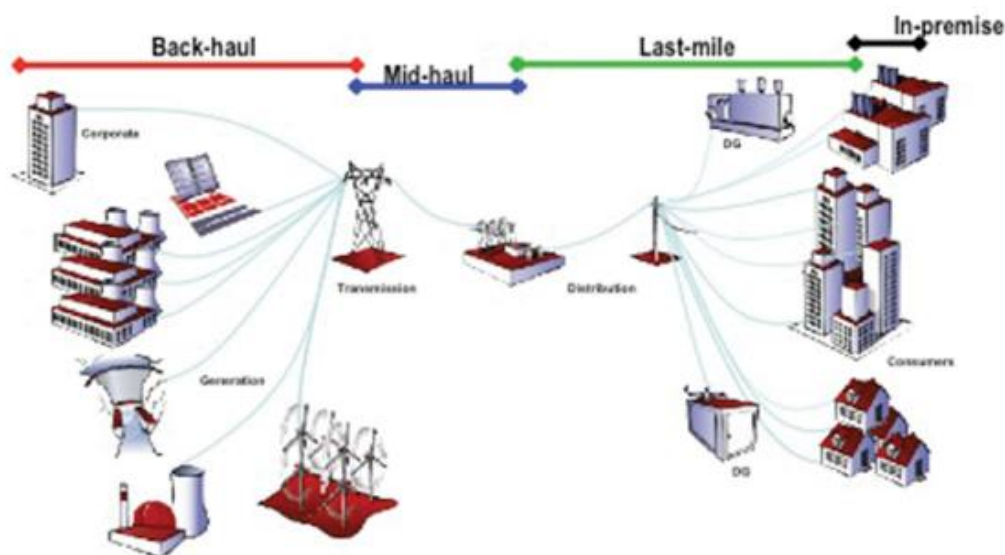

In Fig. 4 is mapped the way the smart network applications and communications technologies can be layered onto the different elements of the energy network physical infrastructure. The communication requirements applicable to generation, transmission, distribution and customer premises have some differences and these are explained in greater detail in the following section.

Figure 4 also illustrates how the communications layer elements, the wide area network, neighbourhood and field area network and the home networks overlap the different power systems elements which make up the energy system.

FIGURE 4  
Utilities communications physical architecture

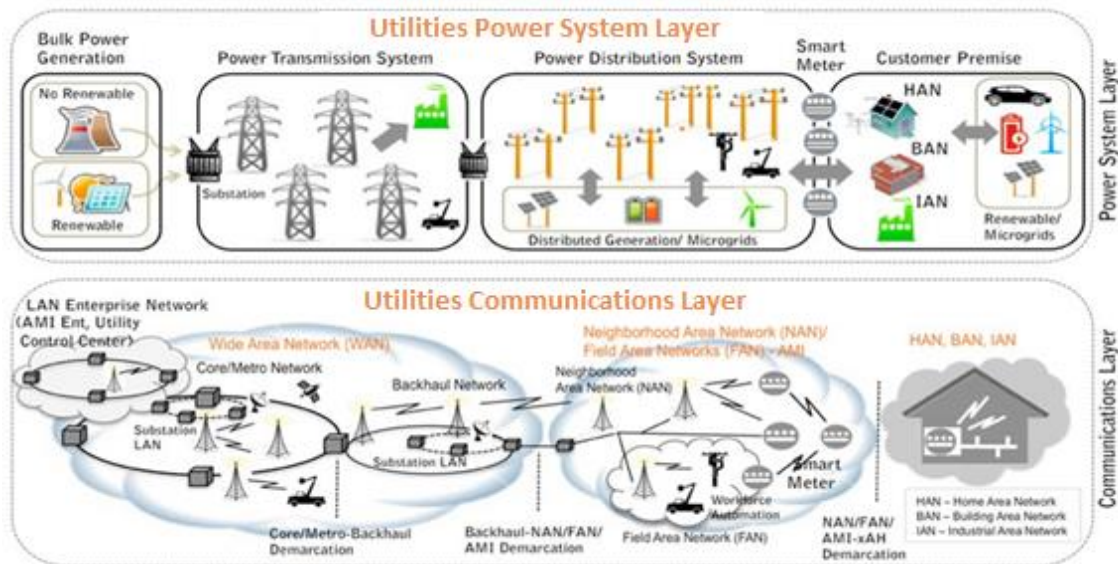

There will be numerous applications, including several that require significantly greater bandwidth. While utilities may not implement all of these applications, they will need to design the FAN so that all of the applications that they do implement can be supported both now and, in the future, as demands increase.

In addition, the network needs to be designed so that it is reliable and provides coverage and low latency to meet their functional requirements effectively.

Flowing from the applications and their functional requirements, utilities may choose the network architecture that best supports their needs, and there are advantages and disadvantages to each.

## 4 Utility radio communications systems

### 4.1 Overview

The process of modernization of the public service sectors utilities has been the main initiative of the governments in the worldwide and seeks to correct distortions and inefficiencies identified over time, as well as to internalize new technologies and business models that have emerged in other markets as a result the processes of decarbonization of energy matrices, climate change, the decentralization of energy resources and the digitization of network elements.

For the electric sector, this means the management of the distribution networks as a business platform that allows the use of the demand response as an instrument of load and power balance, the efficient dispatch of distributed resources. In other words, for the electricity sector as a whole to have economic and financial sustainability, the consumer must become the protagonist.

The radiocommunication system is an important alternative for utilities to reach the most industrial sites (power plants, substations, shops) everywhere and also their customers in any place (urban and rural areas). Utilities utilize communications networks with a high grade of availability and reliability to support for operational safety of the underlying electric, gas and water services that they support. This includes redundant routing of backbone and backhaul networks and also extended backup power at every wireless station. In addition, energy networks utilize low latency applications as protection systems and synchrophasors in order to guarantee that faults do not cause the ripple effect and widespread outages and/or safety issues. Finally, some of the key characteristics of the operational

communications components of utility networks are highly ruggedized for extreme conditions within the substation environment and have traditionally used extended depreciation cycles, so that the communications network devices must last for an extended period of time.

## 4.2 Grid modernization

Society as a whole is living with new technologies that demand changes with an increasingly intense speed. Different disruptive technologies such as Artificial Intelligence (AI), Machine Learning, Internet of Things and Blockchain, have provided tools that, properly used, can bring benefits to the strategies of companies and the results of their businesses, as well as the way they can be used to their advantage. Considering the benefits of these features, it is very worthwhile to implement them in businesses. This means that information from the entire plant needs to be available for proper treatment and decision making.

For modernization to happen at all levels, a highly reliable communication system with a high availability index is essential.

The radiocommunication systems has fundamental importance for utilities to support any kind of applications that need high reliability and availability such as automation and control, teleprotection, routine processes of dispatch and emergency restoration, advanced metering infrastructure (AMI) and Distributed Generation.

Details of communication systems supporting those applications are described in Report ITU-R M.2014 and Report ITU-R SM.2351.

Besides fixed wireless for backbones, the utilities also use fixed wireless as backhaul to provide point-to-multipoint communications with high and medium capacity to access remote substations, border metering, remote electrical grids, special customers, etc.

Utility grid modernization represents a fundamental change in the way that utility networks currently operate; for example, dynamically responding to an isolated fault and rerouting power before it leads to a widespread and extended outage or anticipating the fault before it occurs and changing out a transformer before it fails. In addition to fixed operations for intelligent electronic devices on the grid, grid modernization also envisions mobile data applications to trucks and field personnel so that they can access files with information about utility infrastructure as they are restoring power and then communicate back remotely to the utility when the work is completed, and power has been restored. Such developments could dramatically reduce the time it takes to restore power and improve the safety and efficiency of operations overall.

As well as monitoring and controlling the grid more actively and intelligently, the capacity of the grid to deliver energy can be increased if assets are monitored and controlled dynamically. For example, the power which a cable can carry usually depends on worst-case static rating. However, if the actual temperature of the cable can be monitored, it may be possible for the cable to carry more power if it is being cooled by the wind. This is especially important when providing connections to wind farms, as they only generate power when the wind is blowing, and thus it may be that existing power cables can convey extra power from a wind farm without having to construct extra power lines, reducing the cost of supplying the renewable energy and making it much quicker to connect the wind farm. In addition, since the power produced by wind farms varies greatly according to the wind speed, power cables serving multiple wind farms may not have to be rated for the peak power of all the turbines. Instead, the power flowing through the cables can be monitored, and if the maximum rating is exceeded, some of the wind energy can be reduced for a short period to ensure the cables do not overheat. This can be more cost effective than building new transmission lines which rarely ever approach their maximum capacity. However, temperature monitoring of cables is not only important to ensure they are not overloaded, but as the cables heat up, they sag more and potentially cause a

danger. Thus, where cables pass over roads, railway lines or similar obstructions, cable sag can be monitored to ensure safe clearances are maintained.

Grid modernization depends on the underlying communications systems that would support the operational requirements for this modernized grid. The introduction of grid modernization will increasingly require telecommunications networks capable of securing real-time traffic and meeting stringent security, ubiquity, resilience, reliability and availability requirements, inherent in the provision of mission critical services, essential to society. These new applications and intelligent devices, commonly referred to as smart grid, will require utilities to upgrade their existing communications networks. Existing communications systems are characterized by a variety of wireline and wireless systems.

### **4.3 The importance of wireless networks for utilities**

Electricity, water and gas utilities use a wide range of communications systems including narrowband land mobile radio systems to meet their instantaneous push to talk (PTT), data control and dispatch communications and operational needs. Broadband is becoming at the heart of digital transformation of utilities communications as the supply chain and operational command becomes completely digitized.

Electricity is at the top of essential services list to society, whose unavailability or even temporary interruption can negatively affect whole chain of other public services that are also essential to society, such as transportation, health, banking and telecommunications.

The chain that makes up the electricity system is composed of four important sectors: generation, transmission, distribution and supply. These segments operate in an integrated way, being extremely important the management, control, automation and monitoring of the events resulting from human actions and nature that constantly impact the electrical system.

The electrical networks “intelligence” is mainly based on the exchange of real-time information on measurement, supervision and control data, installed in strategic positions in generation, transmission and distribution networks, as well as in homes, offices, companies, with the purpose of making it capable of automatically detecting, analysing, responding and restoring faults in the network.

Non-wireless telecommunications alternatives may be impractical for many applications that would need wide service area coverage and low-cost implementation. For example, it is usually difficult to enable fibre and wired technologies for millions of smart grid devices, many of which may be located in remote and otherwise inaccessible areas across the wide service area of a utility.

Suitable communications technologies can enable more efficient management and control to flow of energy onto the distribution infrastructure. Some utilities are also implementing newer distribution automation technologies thereby enabling utilities to maintain power resilience and restore power more quickly after an outage and protect the utilities’ critical assets against physical and cyber-attacks. These are just some of the utility applications that are creating additional demand for new wireless communications capacity and coverage.

These systems support voice applications, such as routine dispatch and emergency restoration, and for data applications, such as supervisory control and data acquisition (SCADA), distribution automation (DA) and advanced metering infrastructure (AMI). These systems are characterized by wide area coverage, high reliability and availability, and redundancy/resiliency. These systems have transitioned from analogue to digital, and have the ability to support machine type communications.

Utilities also use fixed wireless systems that provide point-to-multipoint communications with high capacity backhaul that operate across different platforms, higher capacity mobile service could be better suited to offer wide area coverage.

## 5 Spectrum related aspects

The key ingredient to maintaining these Smarter Utilities Networks is radiocommunications. Energy and water providers operate mission-critical functions like SCADA systems that are used to manage industrial control systems such as electric grids, protective relaying and smart grid applications. Additionally, utility workers use mobile radio devices to communicate when repairing lines or restoring service after an outage. The inability of utility personnel to communicate in the field could have catastrophic consequences for utility employees and public safety.

Utilities use a variety of wireless technologies to support their various mission critical applications. For protective relaying, utilities report that they use a mix of fixed wireless access and land mobile systems, as well as optical fibre and power line communications. Similarly, for SCADA systems, utilities report that they rely more heavily on wireless communications, using a mix of fixed wireless access and land mobile systems. For operational voice and data communications utilities report that they use a combination of fixed and mobile communications systems for substations, power plants, control centres and field staff, and they use land mobile systems to a greater degree for field area communications with staff compared to substations, power plants and control centres that predominately use fixed wireless access and wireline communications systems. Utilities also reported that they use wireless services from commercial providers as an alternative to private wireless communications. For remote meter reading, utilities reported that they mainly use a combination of optical fibre, fixed wireless access and land mobile radio systems, and to a lesser degree they use cellular radio systems.

For DDR communications, utilities report that they mainly use fixed wireless access and optical fibre, followed by land mobile radio and other communications systems to a much lesser extent. For distribution automation, utilities report that they use a mix of optical fibre, fixed wireless access and land mobile radio systems.

While some applications are non-mission critical and can be supported using license-exempt spectrum or commercial communications networks and services, many of the applications must meet higher standards for reliability and latency due to their impact on operational safety and security – and will need access to licensed spectrum for utility communications networks. Licensed spectrum is generally less susceptible to interference, operates at higher power and provides greater overall reliability. However, certain applications require greater bandwidth than can be supported using available licensed spectrum. For these applications, utility access to licensed spectrum with greater bandwidth is necessary to support increasing communications requirements.

The energy companies that were surveyed reported they are finding difficulties in expanding services of applications that use wireless solutions in land mobile service bands, using channel bandwidths of 12.5 kHz or 25 kHz. For each new requirement, especially in existing sites, utilities often require the licensing of a new channel. If the adjacent channel is unavailable, a new frequency should be requested to the telecommunication's regulatory agency, which causes the use of a variety of frequencies that are not necessarily adjacent or contiguous to be reused for wideband or broadband. If frequency bands with a larger channel bandwidth were made available, it could enable introduction of broadband applications. Because of the increase in the demand by applications for grid modernization, smart grid, distributed generation, IoT, demand management, etc., the availability of spectrum with higher bandwidths will be crucial to utilities.

### 5.1 Utility spectrum bands and applications

Modern utilities must support an increasingly diverse array of fixed and mobile utility applications using licensed spectrum, and they use their communications systems to support various voice and data applications. Utilities also use license-exempt spectrum to provide additional capacity.

Many of the utility applications considered in this Report are fixed, but many utility applications are also mobile. The fixed applications include remote terminal units (RTU) and other devices that operate across utility transmission and distribution networks; and unlike older one-way relatively slow speed devices that utilities have used in the past, these devices enable two-way, real-time communications that would provide utilities with much better visibility and control over their entire critical infrastructure delivery networks.

In addition to fixed operation for intelligent electronic devices on the grid, grid modernization also envisions mobile data applications to trucks and personnel so that they can access files with information about utility infrastructure as they are restoring power and then communicate back remotely to the utility when the work is completed, and power has been restored. Such developments could dramatically reduce the time it takes to restore power and improve the safety and efficiency of operations overall.

Grid modernization depends on the underlying communications systems, which in turn are dependent upon access to sufficient and suitable spectrum, particularly for field area networks.

## 5.2 Spectrum bands used by utilities

Utilities use a wide variety of spectrum to meet their requirements as illustrated in the following list. Not all of the spectrum in the ranges quoted below is allocated for the land mobile service, but there are large proportions of spectrum in each of these ranges which are allocated to the land mobile service. Portions of the following spectrum bands are used by utilities in some administrations.

- VHF spectrum– for resilient voice communications and distributed automation for rural and remote areas (PTT and SCADA).
- UHF spectrum below 1 GHz for resilient voice communications, wide area tele-protection, SCADA, control, automation.
- Lightly regulated or license exempt shared spectrum for smart meters and non-critical smart grid applications.
- Spectrum in the range of 1 to 3 GHz for more data intensive smart grid, security and point-to-multipoint applications.
- Spectrum in the range of 2 to 30 GHz for broadband mobile applications based on IMT technologies with bandwidth of 20 to 100 MHz within geographically limited areas including within utilities power generation or water/gas treatment and distribution facilities.

Although utilities make extensive use of copper and fibre-based communications systems – and in the case of electricity, communicating down the electrical supply cables in some instances, radio also plays an essential role. Radio is valuable in this role because:

- the communications network can be independent of the assets being managed;
- radio is flexible and can be deployed more quickly than fibre or copper networks;
- if radio services are interrupted, they can usually be restored more quickly than wired systems; and
- radio is more cost effective in many applications.

Radio systems need spectrum in which to operate. Some services may be able to operate in license-exempt bands designed for short range devices (SRDs), but no protection is available for services in license-exempt spectrum bands if they suffer interference. Further information is provided in Annex 6.

### 5.3 Suitable radio spectrum

#### 5.3.1 The case for sharing spectrum

An alternative to using dedicated spectrum for private networks would be for utilities to share spectrum with other network users. A solution such as this would alleviate the issues around finding spectrum and the difficulty for utilities to compete for access to spectrum at auction. However, sharing spectrum involves some trade-offs, because utilities would no longer solely control the network, and that may limit functionality and degrade the quality of service.

#### 5.3.2 Commercial network providers

Another alternative would be for utilities to approach a commercial carrier to manage their utility telecommunication networks. Commercial providers would aim to reduce the cost of building and maintaining the network. While reducing the cost would be a benefit, key issues face commercial providers about the quality of service they would be able to provide, geographical coverage requirement, the security of the supply chain and maturity of new network virtualization and slicing to serve vertical needs. It might be cumbersome to meet all the security and operational service level agreements and data protection requirements that some of the utilities business-critical applications require. It is clear that certain utility applications will have higher requirements than what these commercial providers can offer to utilities, particularly around contractual commitments to high availability and reliability.

Firstly, the utility networks need to provide full coverage of their asset base with 99.999% availability, something that has proven to be commercially unviable for public mobile. Current utility networks are built to cover the entire geographic area with overlap redundancy, power redundancy, strict maintenance schedules and emergency group talk functions. Despite the poor financial case, a commercial provider would have to provide a network that fulfilled all of these criteria.

Secondly, another issue is reliability and resiliency during adverse conditions. Maintaining and re-establishing communications during crises has always been fundamental in recovery plans for utility providers.

Thirdly, concerns surround the level of cyber security of some commercial providers, given some commercial telecommunications providers may not be subject to rigorous requirements in national regulation.

In addition, future changes to global regulation- such as net neutrality and the way third-party/public communication networks may prioritise network traffic going forward.<sup>6</sup>

Many of these aspects were analysed in the publication “Is commercial cellular suitable for mission critical broadband? (2014)”<sup>7</sup>, and the conclusion was that there are necessary and difficult actions needed to enable commercial network as feasible solutions for many utilities services.

The Report outlined five major conditions which would all have to be met before commercial mobile networks could become a viable option for mission critical solutions, including utilities:

- MNOs would have to be constrained to provide the services required by utilities, such as stronger commitments to network resilience, long term commitments on prices and service availability and ownership assurances. These conditions would need to be enforced by National Regulatory Agencies.

---

<sup>6</sup> The Energy Network Association – Position paper “[Need for Increased Spectrum Allocation and Investment in Operational Telecommunications to Support Electricity Networks](#)”.

<sup>7</sup> [Is commercial cellular suitable for mission critical broadband?](#) (2014), Directorate-General for Communications Networks, Content and Technology (European Commission), SCF Associates Ltd.

- Commercial networks would need to be hardened to 99.999% availability, extended geographic coverage and indoor signal penetration.
- Mission critical functions would have to be provided at reasonable cost.
- Specific features required by utilities would have to be provided, for example low latency and guaranteed symmetry.
- National Administrations would have to be convinced that relying on commercial services to support critical national infrastructure is a wise and sustainable option.

## **6 Societal importance of utility radiocommunications**

Utility radiocommunications systems are becoming increasingly important to society. Safe and secure supplies of drinking water, together with the disposal of sewage are essential for life, especially as populations become more concentrated in urban areas. Electricity is now essential for modern society as virtually all the services in developed societies take for granted a reliable electricity supply from which to operate, from the telecommunications networks themselves to the banking systems and refrigeration to preserve food and medicine. However, society is also worried about potential detrimental environment impacts of creating utility services, especially carbon dioxide emissions and climate change. A number of studies have been undertaken to assess the societal impacts of spectrum allocated for utility operations, and are included in Annex 5 to aid understanding of the role radiocommunications play in delivering secure and sustainable supplies of these critical services.

## **7 Summary**

In conclusion, it is critical for policymakers and utilities to understand the volume of data that Utility Communications Networks will need to carry in order to enable the vision of the next generation utility network. There will be numerous applications, including several that require significantly greater bandwidth. While utilities may not implement all of these applications, they should design their networks so that all of the applications that they do implement can be supported both now and in the future as demand increases. In addition, the network needs to be designed so that it is reliable and provides coverage and low latency to meet their functional requirements effectively. Flowing from the applications and their functional requirements, utilities may choose the network architecture that best supports their needs – and there are advantages and disadvantages to each. Thus, different utilities have deployed different network architectures and have gained lessons learned along the way. Key issues going forward include the need for radio spectrum to support these various network architecture and standardization/interoperability of utility networks – which must be addressed in order to ensure operational safety, reliability and efficiency.

To recapitulate, the utilities services network, including the field area network (FAN), bridges the gap between energy consumers and energy providers by connecting monitoring and control technologies with robust command, control, and information processing enterprise applications. There is no single reference design for a FAN: the technologies cover a wide range of radio spectrum and designs philosophies, from mesh to star to hybrid. The choice between licensed or unlicensed technology is made based on traceable requirements, as is the one between private or public network infrastructures. There is little doubt that the multitude of new smart electricity applications will require greater use of radio spectrum, whether in existing frequency bands or in new allocations of different frequency bands.



Interoperable systems and their benefits to society can be seen in many of today's technologies, including IMT networks<sup>8</sup>, Radio Local Area Networks (RLAN)<sup>9</sup> and short-range devices<sup>10</sup>. The utility industry and the smart electricity networks have not reached this level of interoperability, though frameworks and standards are being refined daily. Before a utility assumes a vendor's claim of interoperability for smart electricity products, the vendor should demonstrate test results that confirm any claims.

Many vendors will not be able to meet this requirement at this time, as smart electricity device testing for interoperability is in its infancy. In some instances, the utility's one choice is creating its own test facilities.

Utilities that were early adopters of smart electricity applications and FAN connectivity are providing valuable insight from their experiences that should be leveraged by subsequent adopters. The industry learned that smart grid applications have a wide range of system requirements in the amount of data to be transmitted and the speed at which the data received and acted upon. Network designers must be familiar with detailed use case information in order to plan traffic load. The use cases must include normal, start up and emergency modes. RF modelling prior to final design and purchase decisions, often complex and tedious, is key to understanding the day-to-day operation of these systems. While no single network design will meet all requirements for the industry, let alone a single utility, the technologies are maturing, and real-world experiences is being added into current standards activities.

Smart electricity applications are presented in a number of categories, and the requirements of each of the categories are discussed. The backhaul FAN is critical in overall smart grid performance. This Report includes a discussion of backhaul, the use of commercial or private backhaul options and some guidelines for making these choices. Standards continue to play a role on FAN designs and a discussion of standards, a few examples of standard families are provided. Finally, a wireless FAN relies on radio spectrum, so a summary of spectrum options is also included.

There are different architectures, each with advantages and limitations. The design of the FAN communications network to support day-to-day grid operations must be completed with the same amount of care and diligence as the grid itself. The utility creates its vision of the smart electricity networks by selecting which applications to deploy. These applications have use cases that must be clearly understood. Use cases lead to FAN architecture options and ultimately data throughput needs. Data throughput will determine spectrum requirements and the choice between licensed and license-exempt spectrum. The bandwidth requirements are going to be different for each technology, depending on the applications and the functional requirements for those applications.

Utilities around the world share a common need for radiofrequency spectrum to support their mission critical applications to ensure safety, reliability and security of their operations and the public that relies on their essential electric, gas and water services that they provide. Without these communications systems, electric services are subject to brownouts and blackouts which can extend over large areas if faults are not instantly isolated. Gas services also depend on communications to monitor and control pressure and the flow of gas so that services are also delivered safely and reliably. Similarly, water services use communications technologies to monitor and control the quality of the water and shut-off valves when there are breaks in the water mains. Not only are these communications systems critical for utility applications, but they are also essential for communicating with personnel in the field, particularly in remote areas or when they are restoring service in the

---

<sup>8</sup> [5G - Fifth generation of mobile technologies](#).

<sup>9</sup> Recommendation ITU-R M.1450 on characteristics of broadband radio local area networks.

<sup>10</sup> Recommendation ITU-R SM.1896 on frequency ranges for global or regional harmonization of short-range devices.

aftermath of storms, earthquakes, wildfires and other natural disasters where and when commercial communications networks may be unavailable.

The results of the surveys show that utilities currently use a wide variety of different spectrum bands. The report reflects that utilities increasingly rely on communications to support increasing automation of electric, gas and water services and that the world is becoming even more dependent on reliable electric, gas and water services.

Given the critical nature of electric utility services, providers must make complex and sophisticated choices regarding the communications networks over which the various applications can run. Without flexibility to choose the nature of the technology and the structure of the networks, the continued stability of the power grid will be compromised. These choices are also influenced by the size of utilities and their consumers. Some smaller distribution utilities, for example, may consider reliance on commercial networks a necessity, due to their size, staffing requirements and trade-off between reliability and cost.

## **Annex 1**

### **Digital transformation of energy networks**

#### **1 Utility modernization/digital transformation**

##### **1.1 Electricity utility modernization**

Electricity utility grid modernization represents a fundamental change in the way that electricity utility networks currently operate; for example, dynamically responding to an isolated fault and rerouting power before it leads to a widespread and extended outage or anticipating the fault before it occurs and changing out a transformer before it fails. In addition to fixed operations for intelligent electronic devices on the electricity grid, grid modernization also envisions mobile data applications to trucks and personnel so that they can access files with information about utility infrastructure as they are restoring power and then communicate back remotely to the utility when the work is completed, and power has been restored. Such developments could dramatically reduce the time it takes to restore power and improve the safety and efficiency of operations overall.

##### **1.2 Water and gas utilities digital transformation**

To reduce costs and improve sustainability water/gas utilities are adopting digital transformation; towards smart water/gas management systems to provide resilient and efficient water/gas supply systems. The digital transformation by water/gas utilities involves the adoption of solutions such as digital meters and sensors, supervisory control and data acquisition (SCADA) systems, and geographic information systems (GIS).

The use of digital output instrumentation (meters and sensors) enables the collection and transmission of information in real-time. Continuous monitoring of the network's status is critical and is made possible by using monitoring and control systems such as SCADA. These systems also provide remote operation capabilities and enhancement of decision making. The data gathered from monitoring and control systems can be analysed and applied in asset planning and renewal, network operation and maintenance.

## 2 Overview of smarter electricity networks

In general terms, the traditional electric network is divided into several parts. Power plants or bulk generation, using the high voltage transmission lines that send the power into the grid comprise the generation and transmission systems. The distribution network delivers power to homes and businesses using medium and low voltage grid and the points of supply where the customer is delivered the power; home area networks allow customers to control their energy usage and communicate with the utility.

The distribution system is characterized mainly by a combination of ring, networked and radial topologies, generally operated as a radial network where there is an identifiable single path to a source of power for every load. However, new grid configurations and the use of information and communications technologies (ICT) are beginning to change this model. This radial configuration simplified the engineering to account for one-way power flow in the monitoring, protection and control of the power grid.

Figure 5 schematically illustrates the legacy electricity network configuration.

FIGURE 5  
Electricity network infrastructure

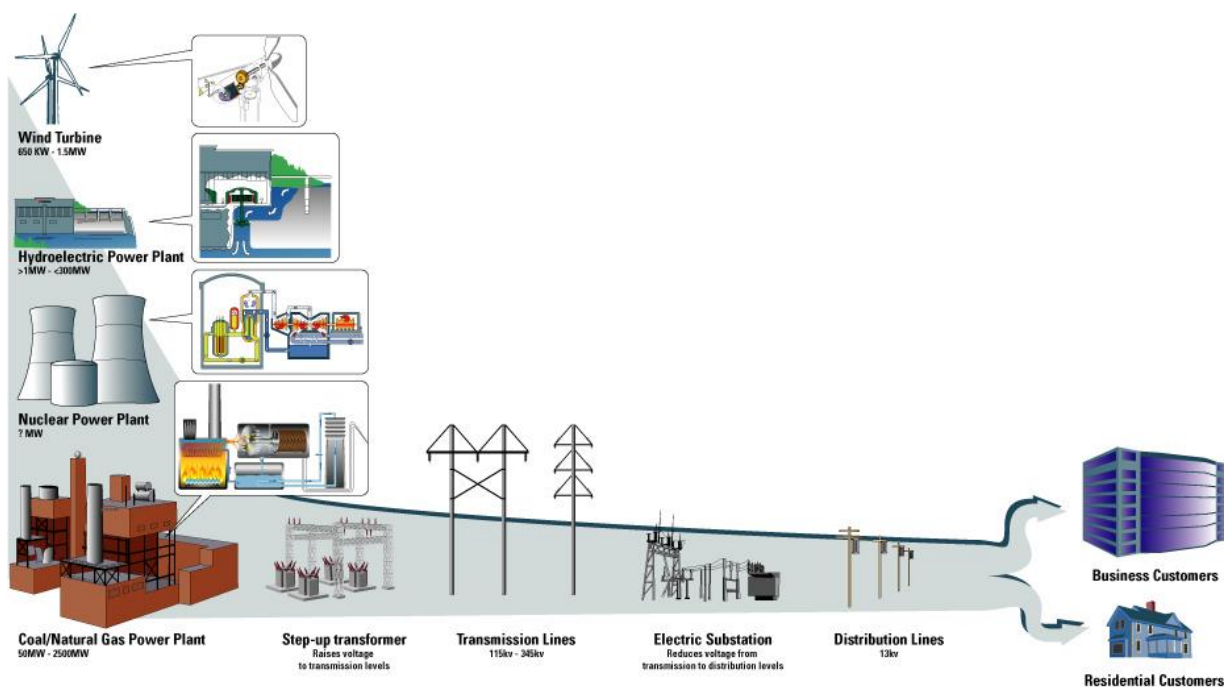

Today's paradigm is vastly different, with the expectation that generation, storage and mobile vehicle load, among other newer applications, create two-way power flows on those same lines, and that the end customer is extremely participative in the overall stability and functioning of that network.

Figure 6 illustrates the major changes taking place in the energy sector as companies are required to develop smarter networks in order to accommodate very large numbers of renewable and low carbon energy sources. The traditional generation plants, very large power stations using fossil fuels are being replaced with much higher number of smaller units using wind, solar and natural gas. These smaller power stations are distributed over a large geographical area and connected not only to the transmission grid but to the distribution grid as well.

In addition, individual companies and individual homes can also generate power from wind and solar and this energy is fed into the energy grid. This has the effect of creating millions of small energy sources which utilities need to manage and control.

FIGURE 6  
Smarter electricity network

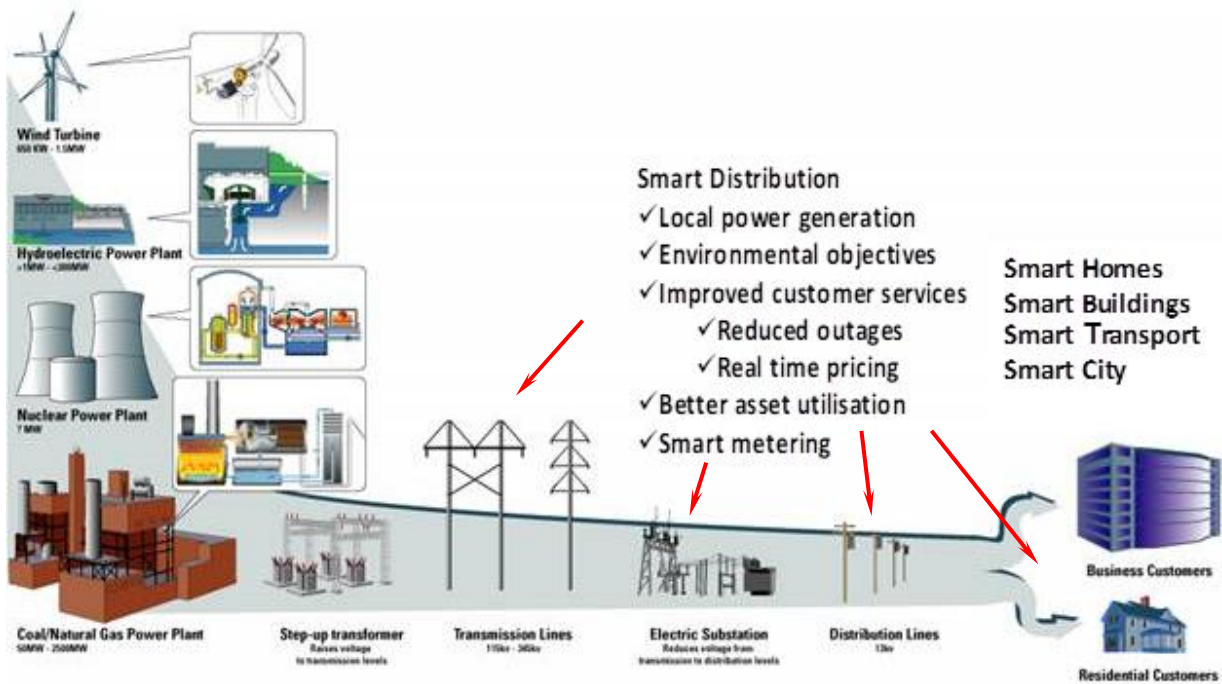

The need to create smart distribution grids is universal across the world. Smart distribution energy networks will be integrated with smart homes, buildings, transport and cities. The key issue for the energy sector is connectivity to the many thousands of assets and energy sources in distribution networks. The information and communications technologies (ICT) needed to manage and control complex smart energy networks demands very high availability and reliability and needs to provide communications connectivity when the energy supply fails. The communications capacity and coverage required in the distribution network is not in place today and energy companies are planning new communications networks and services to meet the needs of smart grids. Many technologies will be used but the grid assets are spread over a large geographical area and in remote locations and therefore wireless communications will play a key role.

Specifically, utilities are deploying real-time, two-way communications networks that extend beyond the distribution substations all the way to the customer premises. These networks must be highly reliable and provide low latency communications. Moreover, the networks must support higher capacity to enable smart grid data traffic from a proliferation of devices that reside on the grid and in the home. Finally, the networks must provide high security to protect against cyber security and other external vulnerabilities.

The increase of renewable energy sources such as solar and wind will put new demands on distribution system operators to be active network managers with total control of the distribution network. Due to inherently increased volatility in renewable sources, there is a need for power grid protection measures which can respond more quickly. Additionally, there is a need to balance production and loads in a more dynamic way, as renewable energy sources have less inertia. Therefore, digitalization and connectivity are considered as key enablers in the transition to renewable power generation<sup>11</sup>.

<sup>11</sup> [Bringing 5G to power, An Ericsson IndustryLab insights report](#), March 2020.

## Power systems going digital<sup>12</sup>

Power systems all over the world are on the cusp of a transition from being highly centralized to supporting more distributed electricity generation and storage.

More connected sensors and smart meters will enable real-time network monitoring, including data about power quality, broken wires and consumption spikes. As a great amount of data is generated from electricity customers at the edge of the network, AI-powered predictive analysis and edge computing can be introduced to reduce costs and increase revenues.

Predictive maintenance based on machine learning and AI may also reduce power outages and improve investment decisions. This predictive analysis can include rapid detection and response to spikes in demand. One example is the mass charging of electric vehicles (EVs) that can be both a challenge and part of the solution.

Another application area, as mentioned earlier, is that of production compensation between many small-scale installations, where it would be possible to achieve an optimal production balance between distributed energy sources. This is done by measuring and compensating for imbalances in the grid.

The need to introduce smart ways to monitor, balance and predict power consumption and generation will thus continue to grow. The power grids of tomorrow will be digital infrastructures, meaning they will be highly connected and automated.

### 2.1 Opportunities and challenges with connected power distribution grids

Enhancing data connectivity for power grids holds societal, regulatory and economic value. Connectivity and automation can deliver higher reliability and better protection of the electric power grid, unleashing great potential benefits for distribution system operators (DSOs) through the following<sup>13</sup>:

- 1) Enabling the scaling up of renewable, distributed energy sources.
- 2) Reducing the impact of interruptions to customers.
- 3) Minimizing damages and costs related to power grid equipment.
- 4) Lowering service costs and reducing the need for troubleshooting.
- 5) Protecting the power grid with peak shaving and frequency regulation.

Terrestrial and satellite networks can be used in combination to ensure seamless connectivity to remote and urban locations<sup>14</sup>.

## 3 Smart network applications and services

Smart Electric Network applications are briefly described below. We have included traditional power grid applications such as SCADA because the traffic for these traditional applications also has to be carried over the communications networks.

---

<sup>12</sup> *Ibid.*

<sup>13</sup> [Bringing 5G to power, An Ericsson IndustryLab insights report](#), March 2020.

<sup>14</sup> [The Role of Satellites in 5G Networks](#), Microwave Journal, May 2020.

### 3.1 Supervisory Control And Data Acquisition (SCADA)

The Supervisory Control and Data Acquisition (SCADA) systems are aimed to supervise, to perform data acquisition and to enable the visualization of a particular process, with the objective of controlling it, providing a high interface level to the system operator, informing in real time about all events of importance occurred in RTU distributed across industrial plants or geographically spread assets.

In this report, SCADA refers to communication between RTU or Intelligent Electronic Devices (IED) deployed in substations (or a generation plants) and other utility relevant assets with the SCADA Master (Control) in the utility Distribution Control Centre (DCC). As an example, an RTU in the substation collects measurement and status information from some or all measurement devices, relays, and other elements in the substation. In response to periodic polls received from the Master, the RTU sends measurement + status messages to the SCADA Master. In addition, events generated at the relays and other instrumentation are transmitted to the SCADA Master as they occur (asynchronously). The RTU also receives controls from the SCADA Master that are delivered to the relays, bay controller, or other devices for necessary action.

For substation automation based on IEC 61850 standards, IEDs deployed at the substation replace traditional relays, bay controllers, other measurement devices, and switchgear. In this case, each IED is capable of direct communication with the SCADA Master Control: direct communication is used for periodic polls from the SCADA Master, measurement + status responses, event reports, and control signals.

### 3.2 Advanced Metering Infrastructure (AMI)

Utilities are deploying smart meters at consumer locations, at their own substations, and at grid borders. Smart meters report electrical measurements (energy, voltage, power, etc.) at frequent intervals (e.g. once every 15 minutes). In addition to billing, these frequent meter measurements are used by many new and emerging applications including Automated Demand Response (ADR), energy management, rate management, power quality, and asset management systems.

In an AMI solution, meters communicate with the utility Meter Data Management System (MDMS) located at the utility DCC. Meters send periodic measurement + status information to the MDMS, often in response to periodic polling from the MDMS. Asynchronous events such as voltage alarms are also sent to the MDMS. The MDMS may also send control signals to the meters (e.g., disconnecting the meter). Currently, there are three different prevalent AMI solution architectures. A utility may deploy one or more AMI solutions in its service area (some of them are illustrated in Fig. 7).

#### **Direct meter connection (Fig. 7A)**

In this approach, communication between each individual meter and the MDMS is carried directly over a communications network to the FAN (such as a 3G/4G wireless broadband connection, utility-owned wireless connections over licensed or license-exempt spectrum, and/or Gigabit Passive Optical Network – GPON – connection).

#### **Power Line Communication (PLC) Neighbourhood Area Network (NAN) (Fig. 7B)**

In this AMI architecture, meters at consumer locations connected to a distribution transformer communicate with a meter data concentrator located near the distribution transformer. The data concentrator aggregates traffic from the individual meters connected to it and connects to the AMI solution's head end over a FAN connection. On the other hand, the MDMS sends control signals to the head end to be forwarded to the meters.

### Radio Frequency (RF) Mesh NAN (Fig. 7C)

An AMI solution over RF mesh uses wireless communication between the meters and a meter data concentrator over licensed or license-exempt spectrum. The meter concentrator is usually deployed at a substation. However, it is not necessary that the data concentrator support only the meters at the customer locations connected to that substation. Communication between a meter and the data concentrator goes over zero or more intermediate meters with each intermediate meter forwarding data received from its neighbouring meter(s) to another meter or to the data concentrator.

To extend the range of an AMI solution (and thus increasing the number of meters in the RF mesh), data forwarder elements may also be deployed on rooftops or poles, for example, as intermediate mesh nodes. Like the PLC AMI solution, the meter concentrator connects to the head end through the substation router or over its own FAN connection. A data concentrator in these solutions can support a large number of meters (up to 10 000 or more).

FIGURE 7

AMI solution architecture

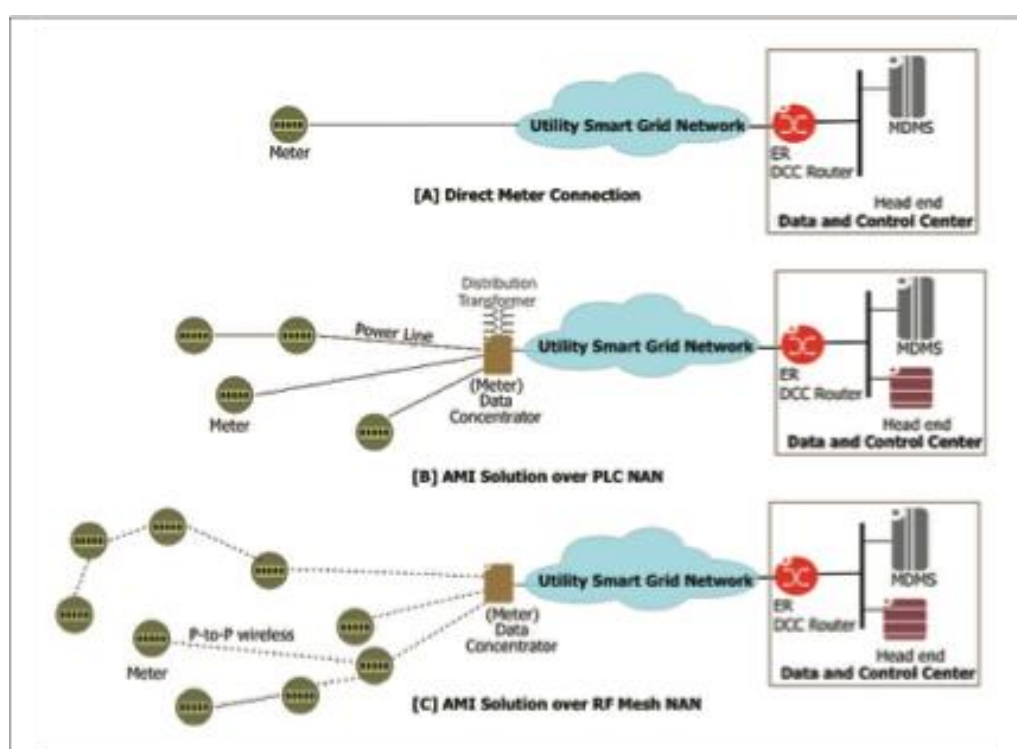

### 3.3 Demand Response (DR)

Demand Response refers to actions taken by a utility to adapt to changes in demand. Some DR methods, such as ADR, occur over the timescale of seconds. New Demand Response solutions require the deployment of new wireless infrastructure to facilitate the increase in generation, transmission, and/or distribution capacity.

### 3.4 Distribution Automation (DA)

DA refers to monitoring and control of IEDs deployed in the utility distribution system outside of the distribution substation. These IEDs may be deployed at reclosers, switches, and capacitor banks installed along feeders (distribution lines) and possibly, in the future, at distribution transformers. The DA IEDs are assumed to use DNP3 to communicate with the DA control system in the DCC. We will refer to this control system as the DA Master.

DA IED functions are similar to those of substation IEDs, possibly with larger interval between sending of the successive measurement + status message.

Each DA IED can connect directly to the DA Master over its individual FAN connection. An RF or a medium voltage PLC NAN can be used to connect the DA IEDs in a neighbourhood to a DA Data Concentrator, typically located at the distribution substation connecting the respective feeders. The DA concentrator, in turn, connects to the DA Master through the substation router or over its individual FAN connection.

### 3.5 Distributed Generation (DG)

Large-scale distributed generation (solar, wind, fuel cells, biomass and biogas, etc.) are an integral part of Smart Grid evolution. DG deployments that require monitoring and control by the utility generate network traffic. These DG sources will be equipped with IEDs. DG IEDs are assumed to use protocols such as DNP3 and IEC 60870-5-104 to communicate with the systems in the DCC. The DG IED functions are similar to those of substation IEDs, possibly with larger intervals between successive measurement+status.

FIGURE 8  
Solar and wind generation



FIGURE 9  
Large scale distribution generation

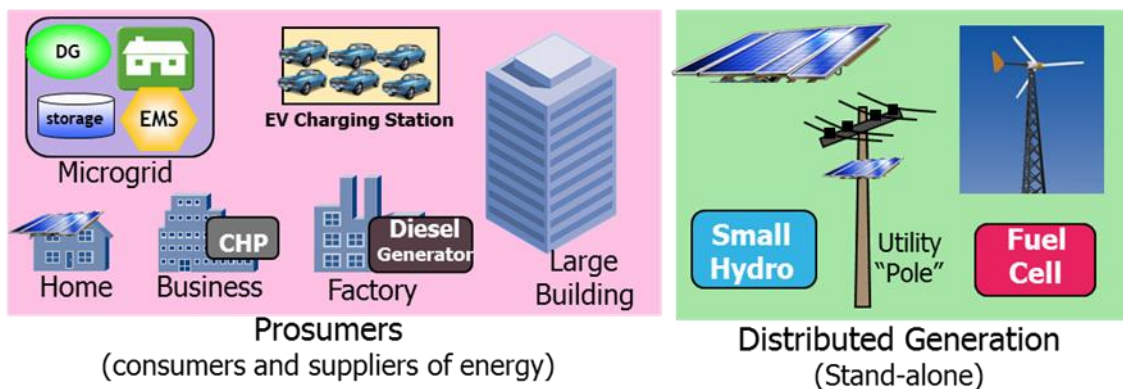

### 3.6 Distributed storage (DS)

In addition to electric energy storage necessary at many DG deployments to mitigate voltage transients, the utility may deploy stand-alone storage facilities such as large batteries, flywheels, super



capacitors, and pumped hydro systems. For the purpose of traffic estimation, the DS IED characteristics will be assumed to be the same as those for the DG IEDs.

### **3.7 Electric vehicle charging stations (EVCS)**

Electric vehicle charging stations that allow EVs parked at the station to discharge energy from vehicle batteries into the grid (in addition to charging EV batteries) can be considered standalone DS deployments. For the purpose of traffic estimation, EVCS IED characteristics will be assumed to be the same as those for DG IEDs. Note that in addition to the periodic measurement+status traffic, there may be (asynchronous) traffic related to authentication (and billing-related) traffic between the EVCS and utility DCC for the vehicles parked at EVCS for battery charging and/or discharging.

### **3.8 Synchrophasors**

Synchrophasors are Phasor Measurement Units (PMU) that measure electrical properties (voltages and currents) of their respective phasor components as well as other quantities (such as line frequency deviation). PMUs are special purpose, state-of-the-art IEDs that report measurement+status at very short intervals (e.g. 60 or 50 times a second).

These reporting intervals are significantly shorter than the several second-long intervals used by SCADA IEDs. PMUs are deployed at transmission substations (TSS). PMU measurements from TSS are collected and analysed to support wide area situational awareness and control of the regional power system. Each measurement+status message from each PMU carries a Global Positioning System (GPS)-derived timestamp. The North American Synchrophasor Initiative Network (NASPInet) is the first network deployed for Wide Area Situational Awareness in regions of North America. While Synchrophasor deployment is currently limited to TSS, their deployment at distribution substations (DSS) for management and control of distribution systems (including power quality control) is also possible in the future.

### **3.9 Dynamic Line Rating (DLR)**

Increasingly, DLR systems are being deployed to monitor environmental conditions at transmission and distribution lines using IEDs. DLR IEDs measure ambient temperature, wind, solar radiation, ice accumulation, sag, and other parameters. By closely monitoring transmission lines, DLR helps utilities optimize power delivery and enhance operational safety. DLR IEDs are assumed to use DNP3 to communicate with systems in the DCC. DLR IED functions are similar to those of SCADA IEDs, possibly with a larger interval between sending of the successive measurement+status messages.

### **3.10 Utility engineering and operations**

In addition to the periodic traffic and asynchronous control traffic between the sensors (IEDs, PMUs, or meters) and their respective operations and control systems at the DCC, other types of data transfer are required for operations and engineering needs. Examples of such data transfer include the retrieval of sensor data for analysis, software/firmware upgrades, remote programming, and configuration of sensors, and, in the case of meters, re-registration of meters after blackouts.

### **3.11 Closed Circuit Television (CCTV)**

Utilities are increasingly deploying CCTV cameras at substations, DCCs, and other locations to support physical and operational security using analytics. Video feeds from cameras are typically stored in local Digital Video Recorders (DVR). At any time, several feeds are also streamed, as necessary, to the (security operations centre within the) DCC. When required (such as during an incident at a substation), one or more live video feeds may also be uploaded to the DCC.

### **3.12 Mobile workforce (MWF)**

Utility mobile workforce requires ubiquitous voice and data communications. Conversational (person-to-person) voice communication between MWF personnel, as well as between MWF personnel and anyone outside the MWF is assumed to have the mission critical communication characteristics. Similarly, the “data” needs (including video) of MWF will be assumed to have the same characteristics. MWF frequently uses Mapping and Geographical Information System applications. Finally, MWF personnel may need to stream live video (from an MWF camera) during an incident.

### **3.13 Protection applications**

Protection applications are designed to ensure electrical equipment safety and reliability in substations and transmission lines, acting quickly and accurately to detect and isolate faults and minimizing the possibility of spreading disturbances to the rest of the interconnected electrical system.

Protection relays in two TSS connected over a transmission power line communicate with each other to detect faults. When a fault is detected, a control signal is sent to trip a circuit breaker. While a fault may be detected and circuit breaker tripped locally at a substation, in many cases, the tripping of a circuit breaker will be triggered by a remote substation.

Protection is a very critical application requiring very short communication delays (often less than 10 ms). Further, for high reliability, two independent connections are used to support communication between the relays. Protection is also used between a DG, DS, and EVCS location and the connecting distribution substation. Protection relays at such locations communicate over a FAN. Protection is typically only used at high-capacity DG, DS, EVCS locations.

### **3.14 Digital Disturbance Recorder (DDR)**

Digital disturbance recorders (DDR) register the operation of the electric system and its protection during important events, such as electric failures, frequency oscillations and operational failures.

Digital Disturbance Recorders, also known as digital oscillographs, are utilized in most of the installations of power electric systems and perform a constant surveillance of the system, recording significant disturbances, such as voltage and current out of the standard.

### **3.15 Precise load control**

The precise load control system focuses on solving the problems of rapid frequency drop at the initial stage of grid failure, overrun of main channel power flow, over-utilization of inter-provincial tie line power, insufficient power grid spinning reserve, etc. According to different control requirements, it is divided into millisecond-level control system to achieve rapid load control and second-level or minute-level control system to be more user-friendly. The former meets the requirements of frequency emergency control to firstly cut off part of the load quickly. The latter secondly cut off part of the interruptible load to achieve the balance of power generation and consumption.

## Annex 2

### General technical and operational characteristics of mission critical utility applications

#### 1 Introduction

Utility systems are composed of various applications that depend on communications. Some of these applications are mission critical, which means that they are used to guarantee security, quality, availability, resilience, and reliability in the provision of essential services to society, whose loss or unavailability can generate not only financial but also social disorders. Other non-mission critical applications help to support utility operations, but do not affect safety, reliability, and security. In general, utilities support mission critical applications using their own private internal communications networks in order to ensure meeting requirements for reliability, availability and low latency. They may use commercial communications networks and services to support non-mission critical applications.

Some examples of utility mission critical applications that require low latency and high reliability include protection, SCADA, remote measurement, mobile voice communications, fixed voice communications, digital disturbance recorders (DDR), synchrophasors, and distribution automation networks.

The following data was gathered in response to a recent survey of utilities presented in the following graphics. The survey was conducted by UTC/UTCAL with thirty-six (36) utility companies in the Americas, Europe and Africa. It encompasses information gathered from different types of utilities, namely generation, transmission and distribution companies.

The following graphics highlight the information gathered from utilities participating in the survey on communications reliability and acceptable latency for mission critical applications.

#### 1.1 Protection applications

When questioned about the maximum latency supported by the protection applications, 69% of the companies participating reported to accept delays of up to 10 ms (33% from 6 to 10 ms and 36% up to 5 ms), while 25% reported to accept delays between 11 ms to 50 ms. More details can be found in Fig. 10. In the case of Brazil, the National System Operator (ONS)<sup>15</sup> network procedures document, in its sub-module 13.2, establishes value smaller than or equal 140 ms as minimum requirement for the communication channels latency.

---

<sup>15</sup> The National System Operator (*Operador Nacional do Sistema Elétrico – ONS*) is the body responsible for the coordination and control of the operation of the energy utilities in the Interconnected National Power System (*Sistema Interligado Nacional – SIN*) and for planning the operation of the isolated systems of the country under the supervision and regulation of the *Agência Nacional de Energia Elétrica (Aneel)*.

FIGURE 10  
Maximum latency supported by protection applications

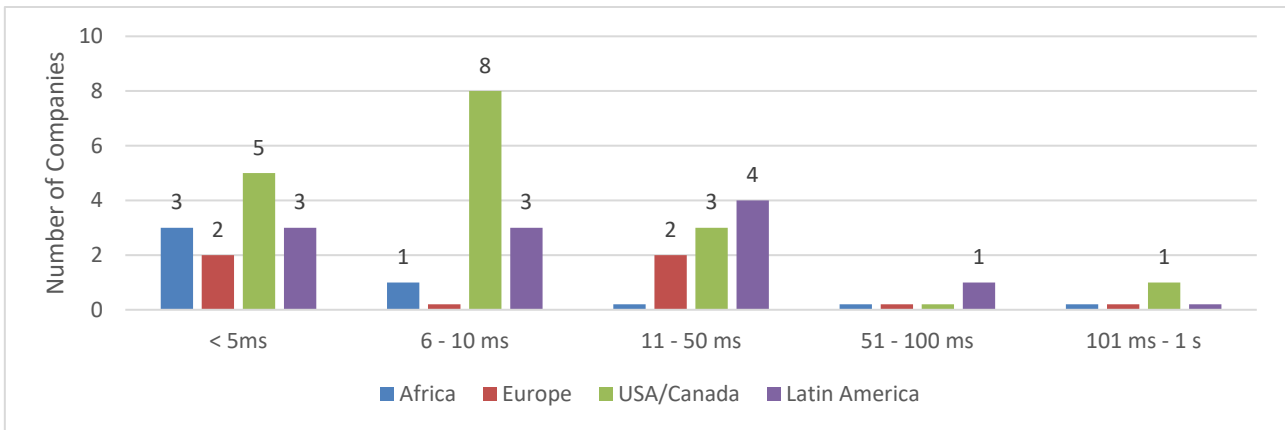

Concerning the minimum availability required for telecommunication systems for protection applications, most of the utilities surveyed reported that they require a percentage equal to or greater than 99%. As can be seen in Fig. 11, twenty-four (24) companies consider availability of at least 99.99% for this type of application.

FIGURE 11  
Minimum availability for protection applications

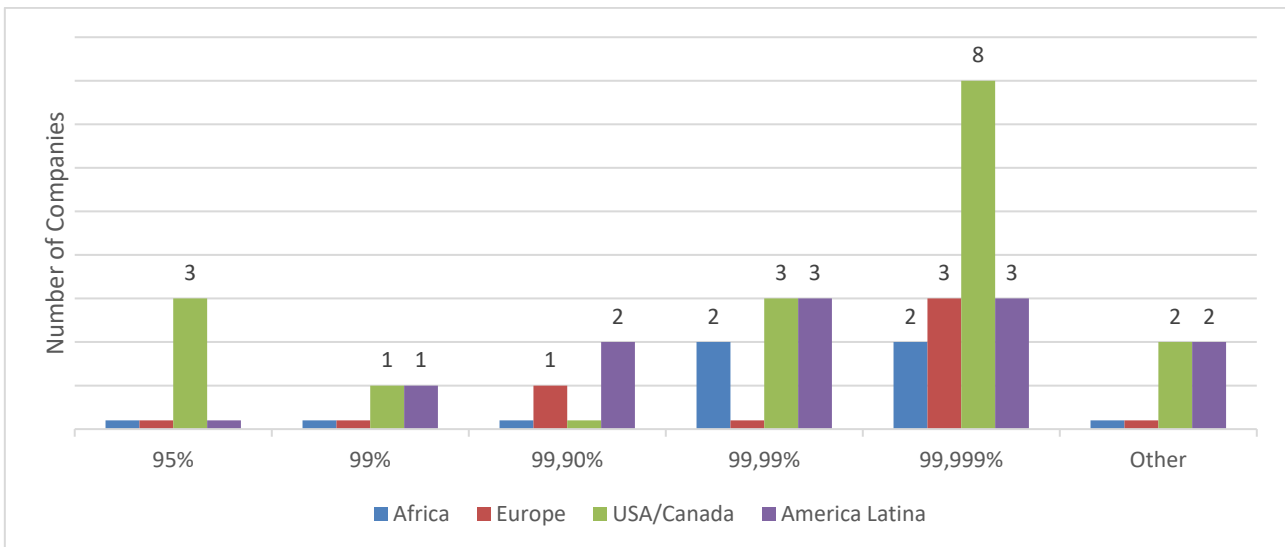

To ensure such availability, the companies use redundant telecommunications solutions typically duplicated fibre optic routes, or a fibre route backed up by a radio link (SHF or UHF).

## 1.2 SCADA

When asked about maximum latency supported by this type of application, 78% of the respondents stated considering a maximum of 100 ms. Among them, 39% claim that the maximum accepted is 10 ms. Figure 12 shows that 17% of the participants accept latencies higher than 100 ms in SCADA systems. Only one company informed (in “others”) that consider a latency of 2 ms as the maximum accepted to support this type of application.

FIGURE 12  
Maximum latency allowed by SCADA applications

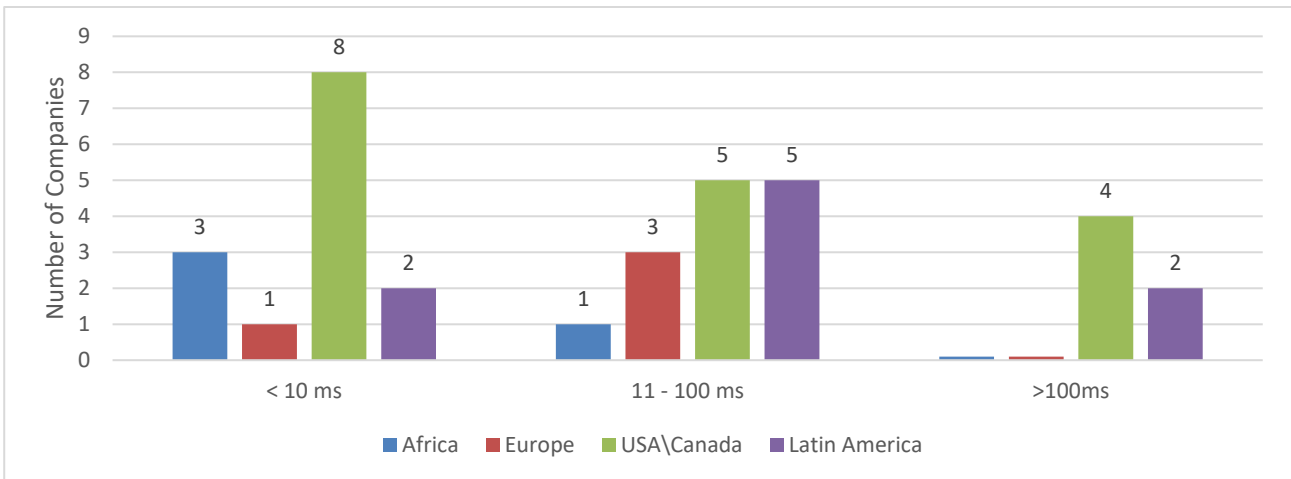

In Fig. 13, most of the participant companies consider adequate an availability higher than 99%, and 83% reported that an availability higher than 99.9% is required.

FIGURE 13  
Minimum availability required by SCADA applications

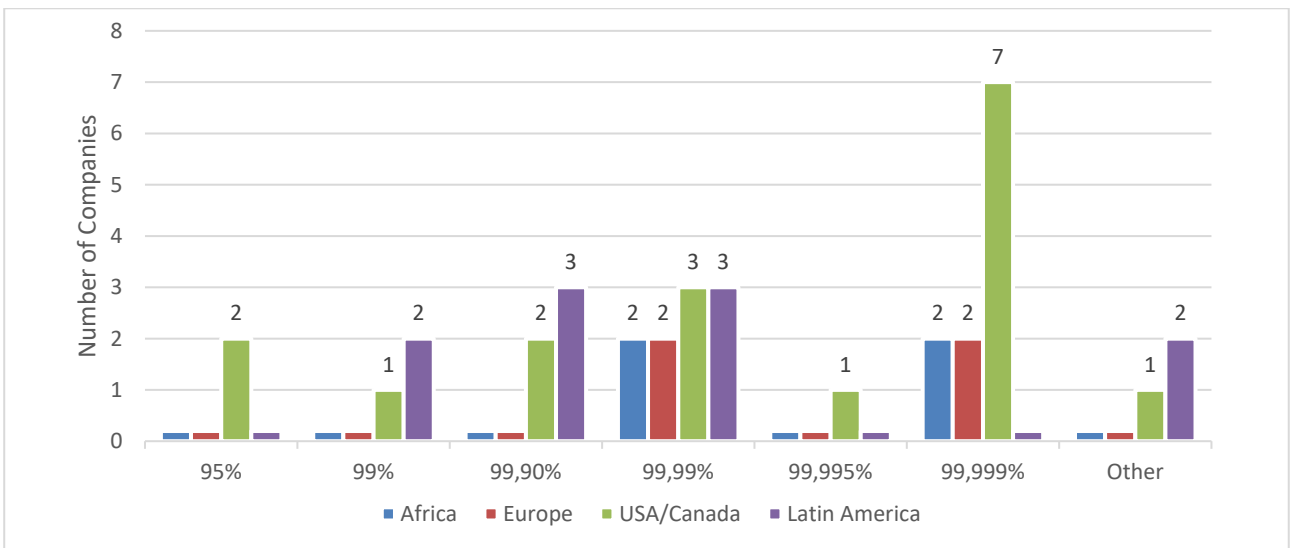

### 1.3 Operational voice and data

When asked about the minimum availability required for operational voice and data applications, the answers were diverse. Thirty-three (33) of the companies do not accept an availability index lower than 99%. The answers can be seen in Fig. 14.

FIGURE 14  
Minimum availability required by operational voice and data applications

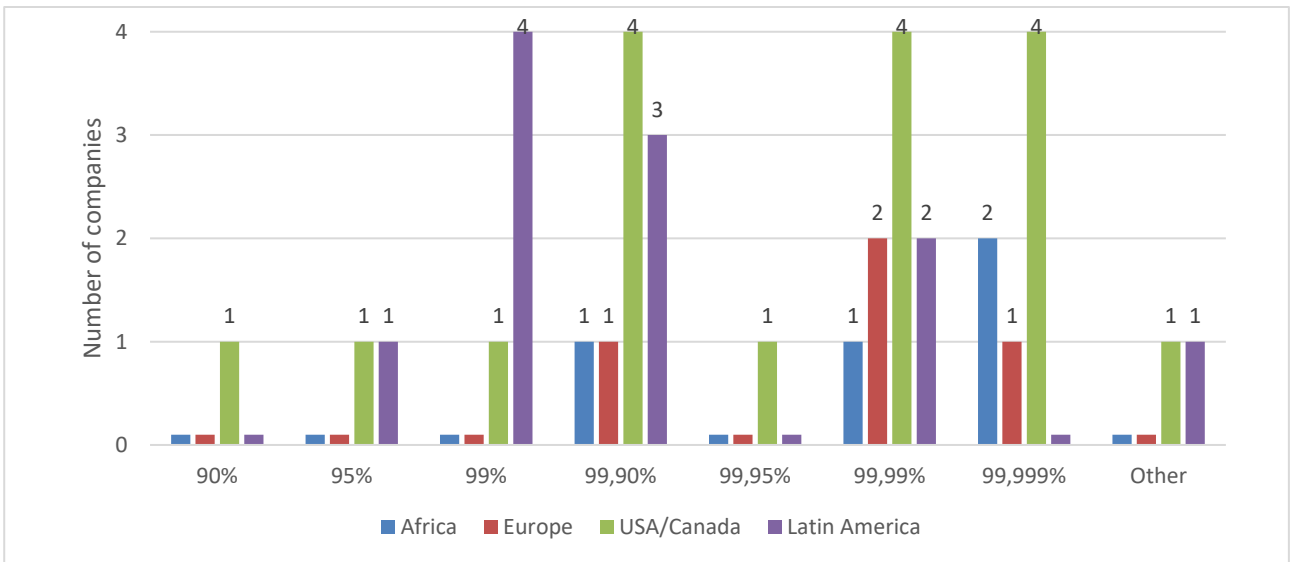

### 1.4 Remote metering

As it can be seen in Fig. 15, most of the respondents (25 companies) informed that remote metering can work with a maximum latency of 3 minutes. Other eleven (11) companies accept latencies higher than 3 minutes.

FIGURE 15  
Maximum latency permitted by remote metering applications

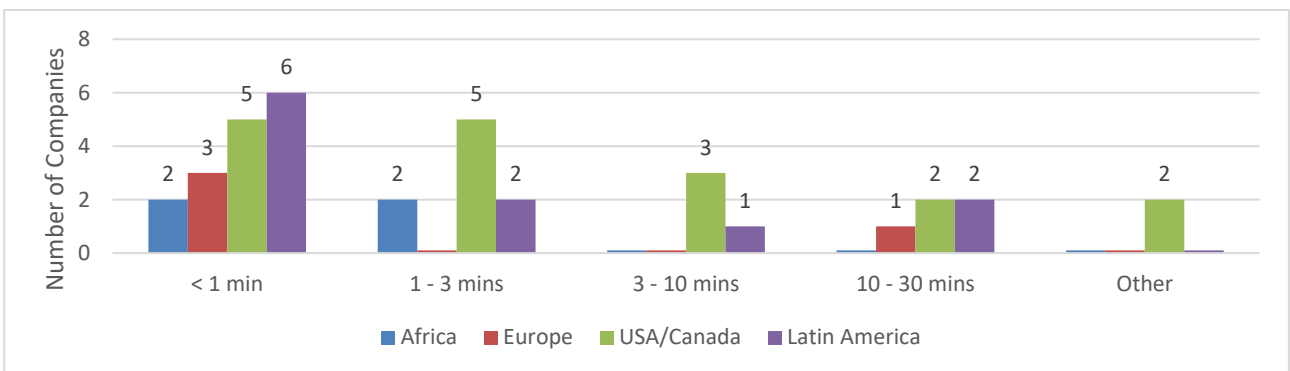

When asked about minimum availability, 31% of companies answered that 99% is the required availability index and 22% consider 95% as the minimum. More details can be seen in Fig. 16.

FIGURE 16  
Minimum availability permitted by this type of application

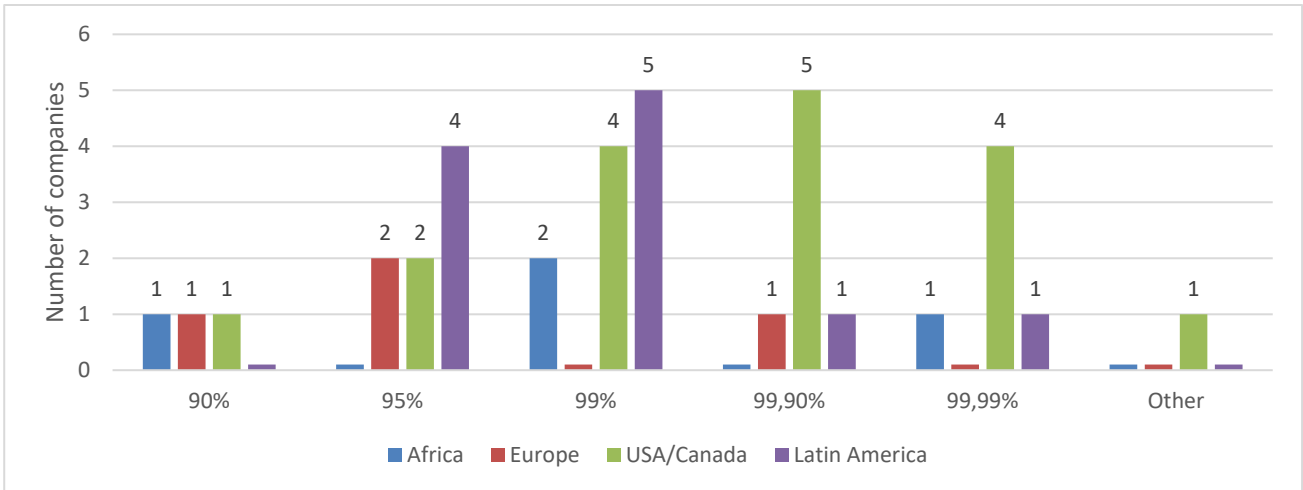

### 1.5 Digital Disturbance Recorder (DDR)

When asked about the maximum latency supported by DDR applications, participants responded a variety of answers. Nine (9) of them informed that 1 s is sufficient for this type of application. Six (6) considers that a latency no higher than 5 ms is necessary. More information can be seen in Fig. 17.

FIGURE 17  
Maximum latency permitted by DDR applications

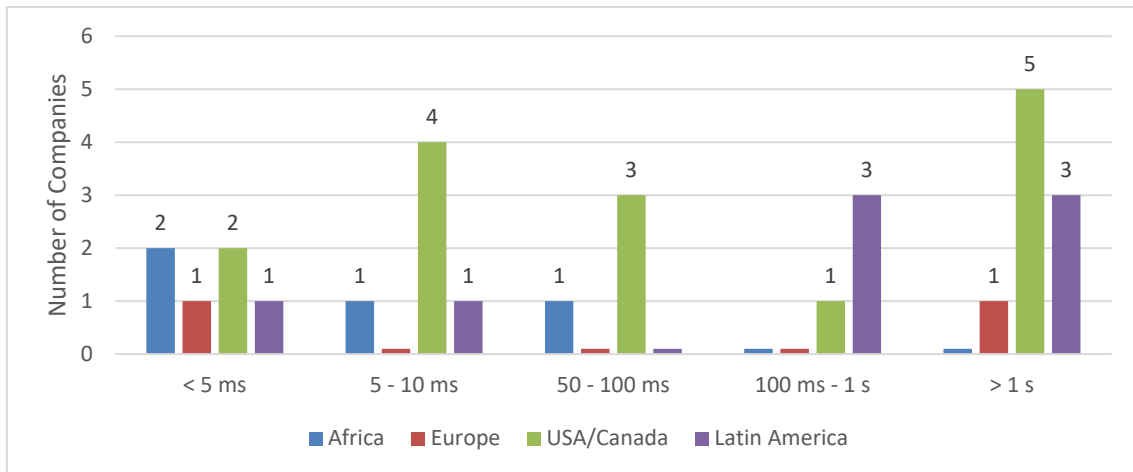

Regarding the minimum availability, most of the companies (22) work with an availability between 95% and 99.9% for their DDR applications, as it can be seen in Fig. 18. One (1) company required availabilities above 99.999% for this type of application.

FIGURE 18  
Minimum availability permitted by this type of application

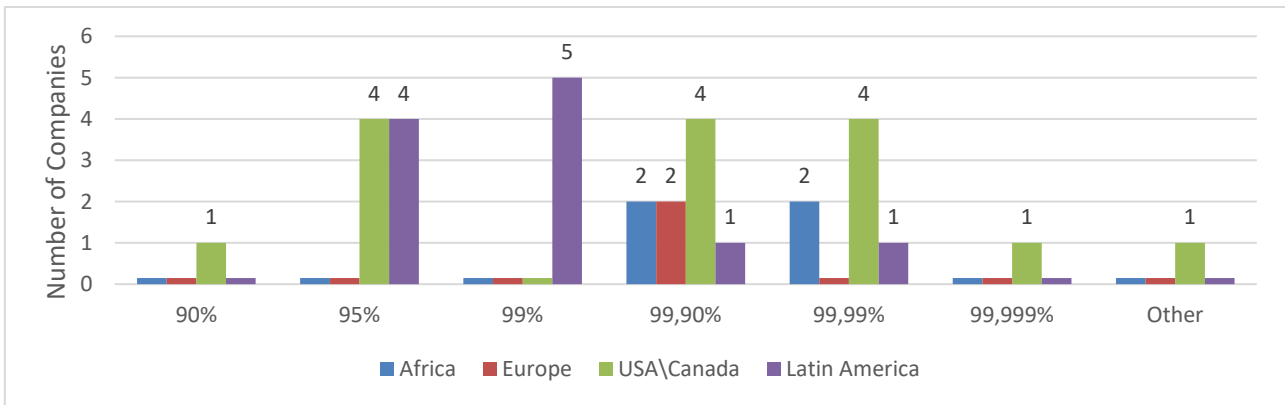

As utilities implement grid modernization more densely and deeper into their infrastructure, their communications networks are expected to need additional capacity and coverage as they shift towards two-way, real-time communications systems that would provide increased control, for example, to turn on/off systems remotely, automatically and dynamically without the need to send out a truck to manually reclose circuits, or when breakers have tripped for example. Moreover, those communication networks will be used to automatically detect a power outage and restore power instantly where, for example, a tree has fallen across a power line or a power transformer has failed. This kind of automation would benefit from additional capacity and coverage functions that would be provided by certain types of radiocommunication systems.

**2 Description of existing communications systems to support utility applications**

Figure 19 shows the different telecommunication solutions used by energy companies that answered to the survey conducted by UTC/UTCAL to support their mission-critical applications. It should be clarified at the outset that each utility may use multiple different technologies to support different utility applications. As a result, the number of utilities reporting about the technologies that they use for certain applications, such as protection or SCADA, may exceed the total number of utilities that responded to the survey.

FIGURE 19  
Number of companies that use different telecom solutions to support their mission critical applications

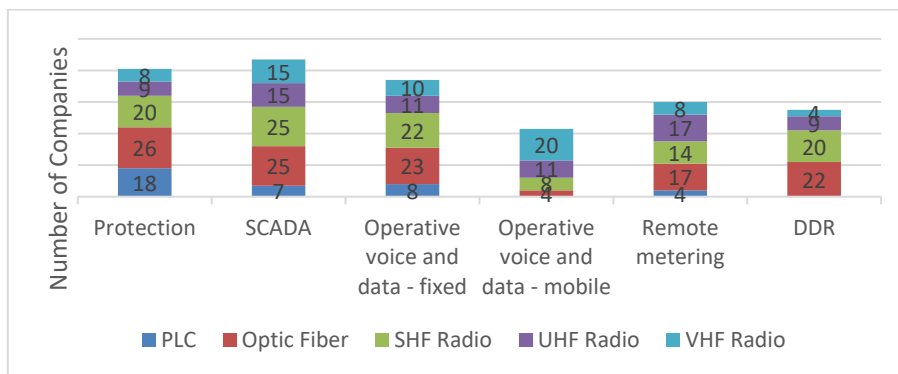



Although optical fibre is widely used in the electrical sector to support utilities' mission critical applications, the use of the wireless solution is also essential, so much in the backbone as in the access to power plants, substations, etc. Wireless solutions ensure that a great number of decentralized resources can be connected more easily and quickly. Wireless solutions are also essential for maintaining communication with the field team in activities related to maintenance and repair of the power grid.

Figure 20 shows the information gathered in the survey in regard to the various wireless technology solutions used by utility companies for each specific type of application.

FIGURE 20  
Wireless telecommunication solutions by type of application

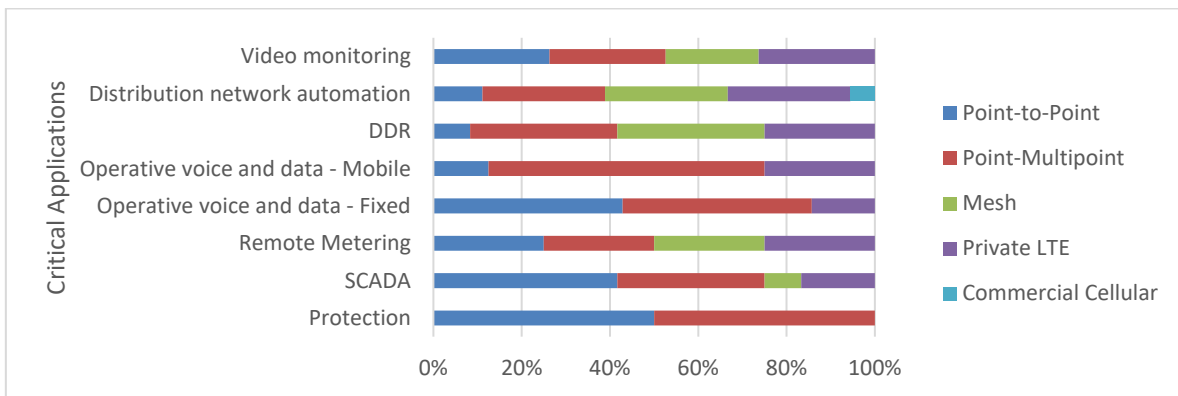

Use of the public mobile service was limited to supporting applications for distribution network automation and only one of the respondents reported that they utilized it. By contrast, use of a private LTE solution by utilities was considered by all respondents as an alternative to most of their utility applications, except for protection. Mesh, according to the respondents, was not used for protection or operational voice and data.

Figure 21 shows the minimum data rate, in kbit/s, required for various utility applications, according to the respondents.

FIGURE 21  
Data rates required to each mission critical application – Energy companies' vision

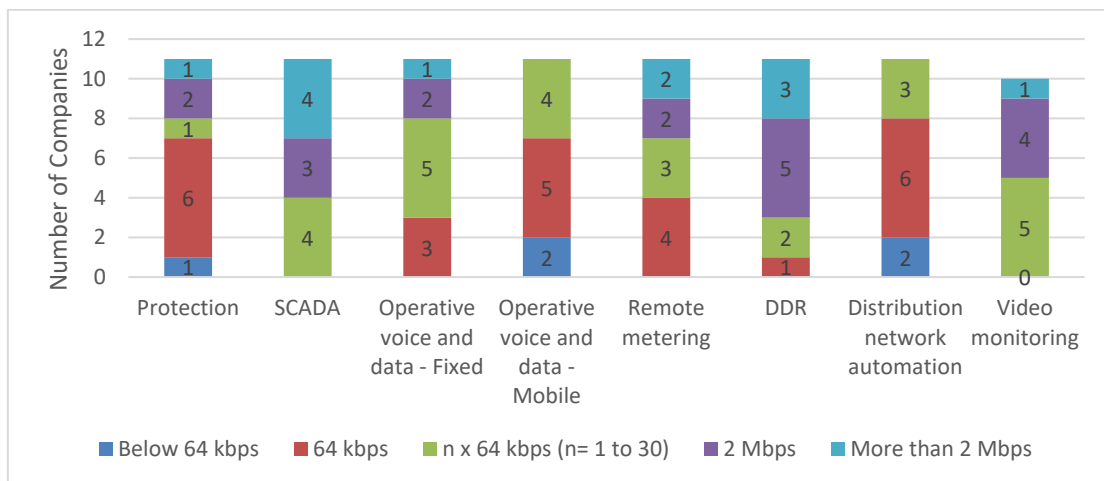

## **Annex 3**

### **An overview of a smart water management system**

#### **1 Introduction**

In a number of countries water supply infrastructures are not adequately funded. They need repair, replacement and expansion to provide access to clean water for sustained economic development and public health.

There is a trend in legacy water management systems towards adopting digital transformation; towards smart water management systems to provide resilient and efficient water supply systems, to reduce costs and improve sustainability. The digital transformation by water utilities involves the adoption of solutions such as digital meters and sensors, supervisory control and data acquisition (SCADA) systems, and geographic information systems (GIS).

#### **2 Smart water management components**

Generally, the technology for smart water management consists of four components:

##### **2.1 Digital output instruments (meters and sensors)**

The meters and sensors provide digital outputs that are used to collect and transmit information in real time. Rain gauges, flow meters are used in water quality monitoring and other environmental data. Acoustic devices are for real-time leakage detection, video cameras for asset management and site security. Pressure monitoring for leakage detection and pump optimization and smart water meters for measuring consumption.

##### **2.2 SCADA systems**

To maintain high water quality requires constant and consistent measurement and oversight. Facilities and plants situated in remote locations must be monitored constantly. The processing and remote operation and optimization of systems and processes is performed with advanced SCADA systems. The applications of SCADA include: pressure management; pump station optimization; water treatment plant control; sewage treatment plant control; and environmental controls.

Remote Terminal Units (RTUs) and Programmable Logic Controllers (PLCs) are connected to sensors and actuators and a combination of radio and fixed lines is used to network the RTUs and PLCs to a supervisory computer system. Wireless SCADA systems using mission critical radios can be cost effective in covering multiple sites in remote locations over wide areas.

##### **2.3 Geographic information system (GIS)**

GIS is used to store, manage, manipulate and analyse spatial information; to develop accurate baseline data. GIS can help provide understanding of assets and conditions. This baseline and monitoring systems will be important for determining realistic and achievable performance indicators. It will also be necessary to understand the hydrological baseline to prove water availability and understand future water availability and possibly quality.

##### **2.4 Application software**

Application software is usually integrated with GIS and/or SCADA systems to manage water networks, monitor sensors and control pressure and other attributes. It is used to improved decision

making and risk management; build customer databases; enable smart metering, billing and collections; hydraulic design and optimization; water resources and hydrological modelling for water security; provide cloud-based data management and hosting options.

Smart systems can provide accurate and up-to-date information that enable informed and systematic decision-making in water management. These systems can, through automation, increase productivity and efficiency in the management of water supply systems.

A key requirement of smart systems is data: its collection, transmission and storage. In implementing the appropriate smart system there are some considerations regarding the data which will be generated:

- The amount of data: data traffic can range from a few bytes per day to megabytes per second:
  - Timeliness of data: once a month, once a day, once a second; real-time?
  - Criticality of the data – is it essential; is it mission critical; is it acceptable to lose a message occasionally?
  - Security and privacy of the data: is the data business critical (for someone to steal), mission critical (for someone to take control).

Where appropriate existing communication networks can be used to carry the data traffic. Such networks include local area networks, cellular 4G/5G networks, fibre/copper networks, low-power wide area networks (LPWAN), and mission critical land mobile radio networks.

## Annex 4

### **Natural Gas example: An overview of transport, storage and distribution<sup>16</sup>**

The efficient and effective movement of natural gas from producing regions to consumption regions requires an extensive and elaborate transportation system. In many instances, natural gas produced from a particular well will have to travel a great distance to reach its point of use. The transportation system for natural gas consists of a complex network of pipelines, designed to quickly and efficiently transport natural gas from its origin to areas of high natural gas demand. Transportation of natural gas is closely linked to its storage: if the natural gas being transported is not required immediately, it can be put into storage facilities until it is needed.

There are three major types of pipelines along the transportation route: the gathering system, the interstate pipeline system, and the distribution system. The gathering system consists of low pressure, small diameter pipelines that transport raw natural gas from the wellhead to the processing plant.

Natural gas processing consists of separating all of the various hydrocarbons and fluids from the pure natural gas, to produce what is known as ‘pipeline quality’ dry natural gas. Major transportation pipelines usually impose restrictions on the make-up of the natural gas that is allowed into the pipeline. That means that before the natural gas can be transported it must be purified. While the ethane, propane, butane and pentanes must be removed from natural gas, this does not mean that they are all ‘waste products’.

---

<sup>16</sup> Source: <http://naturalgas.org/naturalgas/>

## **1 Transmission pipes**

Pipelines can be characterized as interstate or intrastate. Interstate pipelines are similar to in the interstate highway system: they carry natural gas across state boundaries, in some cases clear across the country. Intrastate pipelines, on the other hand, transport natural gas within a particular state. This section will cover only the fundamentals of interstate natural gas pipelines, however the technical and operational details discussed are essentially the same for intrastate pipelines.

The interstate natural gas pipeline network transports processed natural gas from processing plants in producing regions to those areas with high natural gas requirements, particularly large, populated urban areas. The pipeline network extends across an entire country.

Interstate pipelines are the ‘highways’ of natural gas transmission. Natural gas that is transported through interstate pipelines travels at high pressure in the pipeline, at pressures anywhere from 200 to 1 500 pounds per square inch (psi). This reduces the volume of the natural gas being transported (by up to 600 times), as well as propelling natural gas through the pipeline.

Interstate pipelines consist of a number of components that ensure the efficiency and reliability of a system that delivers such an important energy source year-round, twenty-four hours a day and includes a number of different components.

## **2 Compressor stations**

As mentioned, natural gas is highly pressurized as it travels through an interstate pipeline. To ensure that the natural gas flowing through any one pipeline remains pressurized, compression of this natural gas is required periodically along the pipe. This is accomplished by compressor stations, usually placed at 40 to 100 miles intervals along the pipeline. The natural gas enters the compressor station, where it is compressed by either a turbine, motor, or engine.

## **3 Metering stations**

In addition to compressing natural gas to reduce its volume and push it through the pipe, metering stations are placed periodically along interstate natural gas pipelines. These stations allow pipeline companies to monitor the natural gas in their pipes. Essentially, these metering stations measure the flow of gas along the pipeline and allow pipeline companies to ‘track’ natural gas as it flows along the pipeline. These metering stations employ specialized meters to measure the natural gas as it flows through the pipeline, without impeding its movement.

## **4 Valves**

Interstate pipelines include a great number of valves along their entire length. These valves work like gateways; they are usually open and allow natural gas to flow freely, or they can be used to stop gas flow along a certain section of pipe. There are many reasons why a pipeline may need to restrict gas flow in certain areas. For example, if a section of pipe requires replacement or maintenance, valves on either end of that section of pipe can be closed to allow engineers and work crews safe access. These large valves can be placed every 5 to 20 miles along the pipeline and are subject to regulation by safety codes.

## **5 Control stations and SCADA Systems**

Natural gas pipeline companies have customers on both ends of the pipeline – the producers and processors that input gas into the pipeline, and the consumers and local gas utilities that take gas out of the pipeline. In order to manage the natural gas that enters the pipeline, and to ensure that all customers receive timely delivery of their portion of this gas, sophisticated control systems are required to monitor the gas as it travels through all sections of what could be a very lengthy pipeline network. To accomplish this task of monitoring and controlling the natural gas that is traveling through the pipeline, centralized gas control stations collect, assimilate, and manage data received from monitoring and compressor stations all along the pipe.

Most of the data that is received by a control station is provided by SCADA systems. These systems are essentially sophisticated communications systems that take measurements and collect data along the pipeline (usually in a metering or compressor stations and valves) and transmit it to the centralized control station. Flow rate through the pipeline, operational status, pressure, and temperature readings may all be used to assess the status of the pipeline at any one time. These systems also work in real time, meaning that there is little lag time between the measurements taken along the pipeline and their transmission to the control station.

The data is relayed to a centralized control station, allowing pipeline engineers to know exactly what is happening along the pipeline at all times. This enables quick reactions to equipment malfunctions, leaks, or any other unusual activity along the pipeline. Some SCADA systems also incorporate the ability to remotely operate certain equipment along the pipeline, including compressor stations, allowing engineers in a centralized control centre to immediately and easily adjust flow rates in the pipeline.

## **6 Storage**

Natural gas, like most other commodities, can be stored for an indefinite period of time. The exploration, production, and transportation of natural gas takes time, and the natural gas that reaches its destination is not always needed right away, so it is injected into underground storage facilities. These storage facilities can be located near market centres that do not have a ready supply of locally produced natural gas.

## **7 Distribution**

Distribution is the final step in delivering natural gas to customers. While some large industrial, commercial, and electric generation customers receive natural gas directly from high-capacity interstate and intrastate pipelines (usually contracted through natural gas marketing companies), most other users receive natural gas from their local gas utility, also called a local distribution company (LDC). LDCs are regulated utilities involved in the delivery of natural gas to consumers within a specific geographic area. There are two basic types of natural gas utilities: those owned by investors, and public gas systems owned by local governments.

Local distribution companies typically transport natural gas from delivery points located on interstate and intrastate pipelines to households and businesses through thousands of miles of small-diameter distribution pipe. The delivery point where the natural gas is transferred from a transmission pipeline to the local gas utility is often termed the ‘citygate’ and is an important market centre for the pricing of natural gas in large urban areas. Typically, Utilities take ownership of the natural gas at the citygate and deliver it to each individual customer’s meter. This requires an extensive network of small-diameter distribution pipe.

## **8 Delivery of natural gas**

The delivery of natural gas to its point of end use by a distribution utility is much like the transportation of natural gas discussed in the transportation section. However, distribution involves moving smaller volumes of gas at much lower pressures over shorter distances to a great number of individual users. Smaller-diameter pipe also is used to transport natural gas from the citygate to individual consumers.

The natural gas is periodically compressed to ensure pipeline flow, although local compressor stations are typically smaller than those used for interstate transportation. Because of the smaller volumes of natural gas to be moved, as well as the small-diameter pipe that is used, the pressure required to move natural gas through the distribution network is much lower than that found in the transmission pipelines. While natural gas traveling through interstate pipelines may be compressed to as much as 1,500 pounds per square inch (psi), natural gas traveling through the distribution network requires as little as 3 psi of pressurization and is as low as ¼ psi at the customer's meter. The natural gas to be distributed is typically depressurized at or near the citygate, as well as scrubbed and filtered (even though it has already been processed prior to distribution through interstate pipelines) to ensure low moisture and particulate content. In addition, mercaptan – the source of the familiar rotten egg smell in natural gas – is added by the utility prior to distribution. This is added because natural gas is odourless and colourless, and the familiar odour of mercaptan makes the detection of leaks much easier.

## **Annex 5**

### **Utility mission critical communication networks**

#### **1 Spectrum and climate change**

Resolution ITU-R 60<sup>17</sup> resolves that ITU-R Study Groups should develop Recommendations, Reports or Handbooks on, among other things, possible development and use of radio systems or applications which can support reduction of energy consumption in non-radiocommunication sectors. It also resolves that ITU-R Study Groups, when developing new ITU-R Recommendations, Handbooks, or Reports or reviewing existing Recommendations or Reports, take into account, as appropriate, energy consumption as well as best practices to conserve energy. Consistent with Resolution ITU-R 60, it is important to emphasize that utility radiocommunications are essential for supporting applications that help utilities operate more efficiently and help consumers reduce energy consumption, as described more fully below.

For example, utility radiocommunications are critical for monitoring and controlling the balance of electricity on the grid that is generated from distributed energy resources (DER), such as solar and wind. The radiocommunication systems help utilities to balance the flow of energy that is created from DER, so that it can be accepted by the utility and used to provide power to consumers. Some of these DER sources of electric generation can be intermittent in availability, and utilities also use radiocommunications systems to help anticipate when solar and wind energy may be unavailable due to certain weather conditions, such as a cloudy day. The information communicated through utility

---

<sup>17</sup> Resolution ITU-R 60 on reduction of energy consumption for environmental protection and mitigating climate change by use of ICT/radiocommunication technologies and systems.

radiocommunications, enables utilities to manage DER so that these sources of clean energy can be made available for consumers to use in a reliable, safe and effective manner.

Similarly, utility radiocommunications are used for advanced metering infrastructure (AMI) which enable consumers to reduce their energy consumption during periods when electricity demand is high. AMI helps to promote clean energy by reducing the need for utilities to generate additional electricity during these peak periods. By avoiding the need to increase generation during these peak periods, utilities can significantly reduce carbon emissions, which improves environmental quality.

While these applications are visible and provide tangible benefits in terms of clean energy to consumers, they rely on the underlying utility radiocommunications to function properly. Utilities increasingly rely on radiocommunication systems to automate operations, and provide better visibility into their electric, gas and water services to monitor and control the delivery of these essential services, safety and effectively. This is commonly referred to as smart grid, and utility radiocommunications enable modern utility operations through smart grid applications.

Modern utility networks – smart grids – require highly available telecommunications networks.<sup>18</sup> Because of the rapidly changing environment with increased focus on CO2 reduction, climate change and sustainability, these additional controls can only be developed quickly and cost effectively using radio.<sup>19</sup>

Although commercially provided radio telecommunications networks provide good services, they are not configured for critical utility operations. Renewable energy locations are often located in remote areas where there are no commercial networks. Moreover, the electricity sector most needs its communications when there are sustained power outages, and most commercial networks lack sufficient standby energy supplies to maintain communications during extended power outages.

These critical utility operational networks – vertical industries – require access to spectrum for their wireless communications systems. This spectrum needs to support additional capacity and low latency communications, which is required for smart grids. Accordingly, a number of utilities are using spectrum in various frequency ranges below 1 GHz to support their requirements for coverage and low latency communications. Several countries around the world have provided utilities with access to spectrum in the 400 MHz frequency range,<sup>20</sup> which provides sufficient coverage using low frequency spectrum, which is vital for utilities to be able to construct low cost wide-area networks without imposing undue cost burdens on energy and water consumers. Utilities are already highly regulated industries. Global policy objectives to reduce carbon emissions and mitigate for the effects of climate change oblige telecoms regulators to engage constructively with their utility sectors, especially electricity which is the energy source most governments are looking to facilitate these societal transitions.<sup>21</sup>

Direct access to dedicated spectrum supports management and digitization of the rapidly changing energy system and allows for quicker adaptation to renewable energy resources in order to achieve climate targets. Security of energy supply is crucial and of ever-growing importance in our digitized

---

<sup>18</sup> ETSI Technical Report [TR 103 492](#) at Annex C.

<sup>19</sup> Radio Spectrum Policy Group, [RSPG21-026 FINAL](#), “RSPG Report on the role of radio spectrum policy to help combat climate change” at 12-13 (June 16, 2021)(stating that “smart energy and smart grid are examples of how wireless communications can enable more efficient energy use with associated environmental benefits and reduced costs.”).

<sup>20</sup> ETSI Technical Report [TR 103 492](#) at Annex B, “European 450 MHz to 470 MHz band plan options”, and Annex C, “Essential Requirements for Smart Grids” (requiring “cost effective” radio solutions).

<sup>21</sup> Thill, David, “[Smart grid transformation hinges on data bandwidth – and lots of it](#)”, Energy News Network (June 10, 2019).

society. The smart grids require a highly reliable and safe exchange of data for the purpose of efficient grid management. This includes both data providing information about the status of the grid, as well as data to balance supply and demand on a minute-by-minute, even second-by-second basis in some cases. The choices made regarding the underlying telecommunications infrastructure are long term choices (minimum 15 to 20 years) given the investments necessary in the associated energy infrastructure. Using networks operating in spectrum assigned to commercial networks may offer suitable solutions for some utility needs, however there are also needs which cannot be fulfilled by commercial mobile networks. Experience has shown that these commercial mobile networks do not provide sufficient power autonomy (all ‘5G-slices’ are still dependent on the same power supply) nor guarantees concerning the availability and lifecycle of communication technologies, to name some examples.

## 2 Network characteristics

The privately provided broadband radio technologies are instrumental in facilitating the evolution of traditional grids towards the Smart Grid. As pointed out in ETSI Technical Report TR 103 401<sup>22</sup>, Smart Grid services need to rely on a private, reliable (with significant power autonomy), redundant, scalable and high-performance telecommunications network. Broadband radio technologies based on IMT are key to achieving this challenge which necessarily comes along with the need of broadband spectrum exclusively allocated to utilities. Analysis in ETSI report ETSI TR103 492<sup>23</sup>, deduced that 400 MHz networks for Smart Grid “would require  $2 \times 3$  MHz of usable spectrum.” The report further postulated that an allocation of 10 MHz of TDD/FDD channels would ensure that future challenges can be met within the 400 MHz band without supplementing it with blocks of spectrum in higher frequency bands.<sup>24</sup>

The need for private wireless networks for the utility sector and as such access to spectrum is underlined in the recent report by the World Economic Forum (World Economic Forum, Future Series: Cybersecurity, emerging technology and systemic risk, Insight Report, November 2020)<sup>25</sup>. The report states that “However, some infrastructure that does not necessarily fall within the remit of CNI obligation is becoming an increasingly critical component of the supply chain, as reliance on communications infrastructure grows and organizations (including those in CNI sectors such as healthcare, transport and energy) become dependent on shared underpinning digital infrastructure and third-party suppliers while not being granted access to spectrum resources to develop resilient and secure private network alternatives.”

Safe and reliable exchange of data is a fundamental prerequisite for the changing energy field. This necessitates a sufficient level of control over the underlying communication infrastructure; wired and wireless. It is for these purposes that the utilities require direct access to spectrum.

---

<sup>22</sup> ETSI Technical Report [TR 103 401](#) at 23 (stating that “it is essential that the Utility Operations system is self-managed so as to enable the operator(s) to maintain control of the spectrum licence and system so that spectrum access costs may be kept low and the system’s functionality can be assured, e.g. priority access, coverage, latency and power backup requirements,” adding that “it is anticipated that the details of the future spectrum requirements will be expanded within ETSI TR 103 492 [i.26].”).

<sup>23</sup> ETSI Technical Report [TR 103 492](#) at 10 (adding that “Ideally, a harmonized tuning range could be found across Europe, in the 450 MHz to 470 MHz band. Where this is not possible,  $2 \times 3$  MHz anywhere within the 400 MHz Band (380 MHz to 470 MHz) will be acceptable.”).

<sup>24</sup> ETSI Technical Report [TR 103 492](#) at 10 (stating that a 10 MHz of TDD/FDD channel configuration is required “for 1.4 GHz spectrum across Europe for Smart Grids.”).

<sup>25</sup> [Future Series: Cybersecurity, emerging technology and systemic risk](#), World Economic Forum (2020).



### 3 Utility involvement in 3GPP

It is widely recognised that wireless solutions based on the suite of standards developed in 3GPP (LTE, Long Term Evolution), have significant potential to satisfy a large part of the future requirements for utility sector digitalisation, connectivity and ultimately decarbonisation. To a certain extent utilities already make use of public Mobile Network Operator (MNO) solutions based upon standards derived within 3GPP. The large ecosystem of providers and operators has several attractive features for utilities, namely low-cost edge devices, a high degree of cyber security capability and good coverage in populated areas. However, there are limitations to the use of 3GPP based solutions for mission critical applications such as utilities. These limitations can be viewed under two main categories:

- i) Limitation of the basic functionality of 3GPP standards, which have been optimised for consumer grade ‘best efforts’ services rather than mission critical applications;
- ii) Implementation of public networks, which are not designed to be sufficiently robust in terms of power autonomy, coverage, and traffic prioritisation to be sufficient for utility use.

Recognising the huge potential for 3GPP-based solutions to play a role in smart grid connectivity and being aware of the limitations above, utilities began active involvement in 3GPP in 2020. A number of global utilities telecommunications associations collaborate to represent utilities in the numerous 3GPP groups and subgroups which aim to deliver enhanced feature sets and functionality in future LTE releases. A utility task force acts in parallel with similar groups which already exist for other sectors such as Automotive, Railways and Public Safety and Disaster Relief (PPDR).

In the same way that the rail sector seeks additional functionality to eventually allow an ‘LTE-R’ system to replace ‘GSM-R’ and that the PPDR community works to optimise mission critical ‘push to talk’ and ‘Push to Video’, the utilities are striving to achieve refinements and enhancements to improve the usefulness of future LTE-based products by the utilities sector.

Key areas of interest for utilities in 3GPP:

- Traffic prioritisation of SCADA type transmissions over LTE based networks
- Introduction of new globally standardised frequency bands suitable for utility uses (the creation of bands 87 and 88 was largely in response to demands in the utility and blue light sector to be able to have 3GPP products available in the range 410-430 MHz)
- Introduction of a new power class of UE to address the asymmetry in the upload / download capability of LTE networks (utility networks tend towards upload centric rather than download centric as with consumer services)
- Introduction of a 3 MHz RF channel at the RAN layer in 5G ‘NR’ (New Radio) – in order that existing utility spectrum allocations can be used to support 5G NR devices
- Enhanced network management and performance visibility between MNO networks and utility networks in order to take more proactive action during power outages which will allow for faster restoration of both power and telecoms services to consumers.

Utilities are aware that engagement in 3GPP is a long-term project which will evolve over time to maximise the usefulness of LTE-based devices in future private and public implementations. Where the likes of Volkswagen, BMW and Audi are working collectively on items for the automotive sector (V2X for instance) and Deutsch Bahn, SNCF and Swiss Rail work towards rail specific functions, global utility telecommunications associations pull together collective knowledge and influence in 3GPP from both large and small energy generation, transmission and distribution companies.

#### 4 Societal importance of the utility radiocommunications

In 2011<sup>26</sup> and 2013<sup>27</sup> UTC/European UTC and JRC UK carried out two studies to assess the socio-economic benefits of utilities use of radio spectrum to support the complex smart networks of the future. The Executive Summary of the report is included here for information.

- When commercial entities are faced with decisions on whether or not to invest in assets, their decisions are based purely on an economic assessment of the value of such assets to the entity. Where those assets also have a social value, it is for society, through the proxy of government, to assess any additional societal benefits and attribute a financial value to them.
- Public safety organizations and elements of the critical national infrastructure have traditionally used radio communications to underpin their operations. The allocation of this spectrum has historically been made by governments who have implicitly taken into account the socio-economic value in making allocations of spectrum to these sectors.
- With the modern trend towards the application of market mechanisms for the award of spectrum to all entities, including the public sector, utilities will assess the economic value of radio spectrum to them in judging the amount of money to commit to spectrum access in any competitive award process, and the associated business risks. Any societal value will thus be ignored.
- The purpose of this study was to investigate whether there might be an element of socio-economic value attributable to radio spectrum deployed by utilities in the conduct of their business; and if this is the case, to place an indication of the amount of socio-economic value which might thus be overlooked if an award is made purely on the basis of the economic value of the radio spectrum to the utilities concerned.
- There are limitations due to the sources of data used in the report. The data is mainly based around research in the UK and USA and relates to power interruptions to electricity networks stretching back several decades in some cases.
- More study is required on the socio-economic value of radio spectrum used to support utility operations in Europe. This new study should look forward to valuations based on Smart Grid Deployment to facilitate renewable energy generation, greenhouse gas reduction and enhance security of supply.
- On the basis of the available data, the report concludes that the societal benefit of spectrum used by the electricity industry to ensure reliable operation of the electricity supply network may have a societal benefit 50 to 150 times the economic value of the electricity itself.
- Within the resources available for the study, it has not been possible to produce equivalent figures for the gas and water utilities, although it is probable that a similar situation pervades these industries. The impact of disruption to these industries is most probably at the lower end of the multiplier ratio due to much less economic impact from disruption to gas and water supplies, although the social impact of loss of gas and water may be greater under certain climatic conditions.

In addition, the Energy Networks Association, UK and Ireland in its report <sup>28</sup> stated:

---

<sup>26</sup> [The Socio-Economic Value of Radio Spectrum used by Utilities in support of their operations](#), Report by the Joint Radio Company Ltd on behalf of the European Utilities Telecommunications Council (2012).

<sup>27</sup> [The Socio-economic value of spectrum in providing utility services to support their operations](#), Report by the Joint Radio Company Ltd on behalf of the European Utilities Telecom Council (2014).

<sup>28</sup> The Energy Network Association – Position paper “[Need for Increased Spectrum Allocation and Investment in Operational Telecommunications to Support Electricity Networks](#)”.

“Investing in operational telecoms to support the electricity networks, through appropriate spectrum allocation and use, would enable a continued growth in connections of distributed generation, energy storage and technology solutions to actively manage the network. Continued growth of these connections and new technologies is key to the implementation of overall carbon reduction measures. Enhancements and growth in telecommunications would also assist electricity network operators in managing their networks to reduce losses and make more efficient use of assets”.

## **Annex 6**

### **National developments**

Provided for information purposes only to reflect the use and actions of the contributors. Therefore, other member states are not engaged on the content of these national developments.

This Annex serves as a repository of information on utility radiocommunication systems use cases of ITU Members, with details on the technical solution(s) adopted in each case and any other information considered relevant for the work of ITU-R. ITU Members are kindly invited to contribute with information on utility communication networks deployed or planned to be implemented in their jurisdictions.

#### **1 Brazil**

##### **1.1 Background**

The need for modernization of electrical grid has motivated utilities in recent years to seek models of telecommunications solutions that allow them to obtain economic and operational advantages, without compromising the reliability, availability and latency requirements of telecommunications networks.

In Brazil, due to the wide variety of applications required today, most utilities tend to deploy a mix of RF network technologies for mobile applications (trunking), PMP applications (automation of switches in distribution networks) and PTP applications (substation automation). Through the interconnection of FAN (Field Area Network) and WAN (Wide Area Network) telecommunications networks, connectivity is established from meters and network automation devices, through substations to supervision and control centres.

Utilities' private fixed and mobile access networks use the VHF frequency bands 148 to 174 MHz and 225 to 270 MHz, for fixed and mobile services. The band from 148 to 174 MHz utilizes a channel width arrangement that cannot exceed 20 kHz for some frequencies and 12.5 kHz for others, which greatly limits its use in applications that demand greater data transmission capacity. The 225 to 270 MHz FDD band utilizes  $12 \times 1.25$  MHz channel arrangements, which can be authorized individually or in aggregate, with the maximum allowed aggregation of five channels, in order to constitute entire blocks of 2.5 MHz, 3.75 MHz, 5 MHz and 6.25 MHz.

The 900 MHz unlicensed band in the Americas ranges from 902 to 928 MHz entailing a 26 MHz bandwidth. In Brazil, the use of the 900 MHz spectrum (SRD) for utilities' FAN networks is mainly aimed at supporting smart metering (AMI) and distribution network automation (DA) applications.

Currently, the permitted range for unlicensed use is between 902-907.5 MHz and 915-928 MHz. Equipment operating on an unlicensed frequency in Brazil must be homologated by Anatel.

There is an initiative in place conducted by a Brazilian utility in the State of São Paulo that encompasses the experimental deployment of a private LTE network for supporting critical mission applications. The LTE network will operate in the 700 MHz band under a special authorization granted by ANATEL for access to spectrum on a scientific and experimental basis, with a duration of two years. Six radio base stations (e-NodeB) will be responsible to cover around 92% of the Advanced Measurement Infrastructure (AMI) and DA elements. Elements not covered by the private LTE network are currently operating over the public network.

The project includes Customer Premises Equipment (CPE) installation in all automation devices for electrical network monitoring and control, and concentrators/gateways distributed throughout the region. In total, 750 devices will be connected to the six planned radio base stations.

WAN network solutions are used for connecting equipment concentrators to the utilities' core network. It is common among utilities to use radiocommunication systems in the SHF (microwave) band for PTP applications, as the network backbone or as redundancy of optical networks. Frequency bands from 4.4 to 8.5 GHz are generally used by utilities throughout the national territory, as an alternative for extending high-capacity connectivity coverage to remote areas where the fibre optic solution is economically unfeasible.

Although technological evolution facilitates the transport of data over commercially available networks, utilities continue to demand a series of unique requirements to support their operational demands:

- While commercial and domestic requirements are moving towards data transmission capacities more than 30 Mbit/s and possibly ultimately 100 Mbit/s, utilities still require 2.4 kbit/s per site, potentially growing to 10 Mbit/s.
- Geographic coverage includes less populated areas, especially where power lines cross remote regions, with very little interest from commercial telecommunications operators.
- Resilience is necessary for networks to operate in the lack of electrical power for long periods, longer than 24 hours. Commercial telecommunications operators often only provision backup power for a few hours and at some cellular sites there is no backup.
- With regard to teleprotection of electrical network elements, the latency and asymmetry requirements of telecommunications signals are linked to voltage levels, requiring latencies as low as 6 ms with associated asymmetry of less than 300  $\mu$ s.
- Commercial networks are inherently download-centric, while the requirements demanded by utilities are focused on the upload of hundreds of electrical system parameters by a small number of control centres continuously monitoring large geographic areas, which directly depends on the availability and robustness of the means of communication between field devices and the control centre.
- Utilities require high levels of security for their telecommunications networks, not only in terms of integrity to avoid malicious disruptions to utility operations, but also for guaranteed access where denial of service occurs, whether due to network congestion or malicious intent blocking network visibility. Cellular networks can be affected by sudden large demands, for example usage by those attending a football match overwhelming local cellular resource.
- While consumer telecommunications product cycles are shortening so that the products can be obsolete within a year, the infrastructure of electric utilities has a typical life span of 50 years. Telecommunications equipment embedded in a large plant operates continuously – replacing obsolete equipment is a large and complex exercise, as opposed to replacing a Wi-Fi router.

Many energy distributors in Brazil use the services of cellular operators, to establish remote connectivity with their electrical network equipment, mainly in metropolitan areas, through 2G/3G networks. However, the services provided do not meet the above requirements and have low levels of resilience, which compromises the electrical system restoration rates required by the National System Operator (ONS).

Utilities in Brazil also rely upon fixed and mobile satellite connectivity services provided by satellite communications providers for substation connectivity, SCADA, distribution automation, advanced metering infrastructure (AMI), mobile work force and disaster recovery communications, as a back-up alternative to terrestrial systems or whenever there are no available terrestrial communications solutions. In general, mobile satellite communications make use of L-band services while smart grid fixed satellite applications are supported by available C, Ku or Ka-band services.

## 1.2 Regulatory provisions governing the access of utilities to spectrum in Brazil

In Brazil, the telecommunications regulator (Anatel) has already allocated some bands (see attached Table) to fixed and mobile services that can be used by utilities in their own private networks, on a non-exclusive basis. The spectrum assignment process requires that utility companies first obtain a telecommunications license for provision of a Private Limited Service – SLP, prior to obtaining an authorization for the use of radiofrequencies associated to the SLP.

The process for granting the access of utilities to spectrum in Brazil comprises the following steps:

Process of obtaining frequencies by utilities

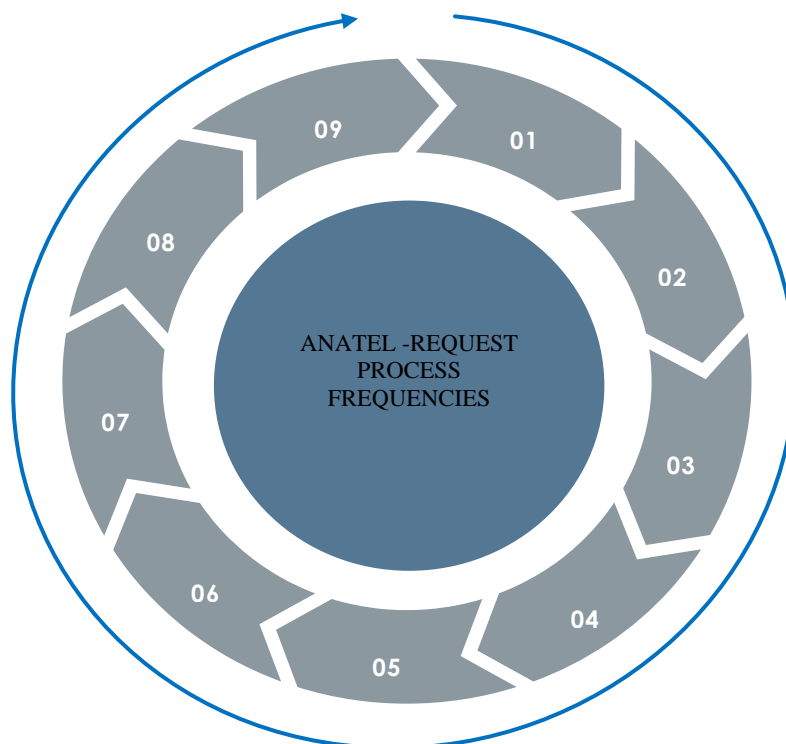

- 1 Identify needs
- 2 Choose frequency range
- 3 Check the availability of channels at Anatel
- 4 Check the interference-free frequencies in the field
- 5 Choose the frequencies
- 6 Formalize to Anatel a request for the chosen frequencies
- 7 Anatel grants the requested frequencies
- 8 Payment of fees
- 9 Implement the designed communication system

**Summary of the technical characteristics of private utility radiocommunications in Brazil**

<b>Spectrum bands</b>	<b>Spectrum assignment method used (auction, direct assignment, etc.)</b>	<b>Radiocomm. service (FS, MS, FSS, etc.)</b>	<b>Communications system architecture</b>	<b>Technologies or Technical Characteristics</b>	<b>Channel bandwidth</b>	<b>Utility applications supported by the communications systems</b>
148-174 MHz	Direct Assignment	FS, MS	FAN	PMR/LMR – PMP Radio	12.5, 20 kHz	SCADA, Distribution Network Automation, Limited Remote Metering, Operational Voice and Data
225-270 MHz	Direct Assignment	FS, MS	FAN	LTE 250 MHz PMR/LMR – PMP Radio	25 kHz (199 channels), 1.25, 2.5, 3.75, 5, 6.25 MHz	SCADA, Digital Disturbance Recording, Distribution Network Automation, Limited Remote Metering and AMI, Operational Voice and Data, Field Force Mobility Applications
360-380 MHz	Direct Assignment	FS, MS	FAN	PMR/LMR – PMP Radio	25 kHz, 1,25 MHz	SCADA, Digital Disturbance Recording, Distribution Network Automation, Substation Automation, Limited Remote Metering, Operational Voice and Data
380-400 MHz	Direct Assignment	FS, MS	FAN	PMR/LMR – PMP Radio	25 kHz	SCADA, Distribution Network Automation, Substation Automation, Limited Remote Metering, Operational Voice and Data
451-458 MHz / 461-468 MHz	Direct Assignment	MS	FAN	IMT (3GPP Band 72) + NB-IoT (3GPP Band 31)	25 kHz, 200 kHz	SCADA, Distribution Network Automation, Substation Automation, AMI, Operational Voice and Data, Video Monitoring
458-459 / 468-469 MHz	Direct Assignment	MS	FAN	PMR/LMR – PMP Radio	25 kHz	SCADA, Distribution Network Automation, Substation Automation, Operational Voice and Data, Video Monitoring
703-708 / 758-763 MHz	Direct Assignment	MS	FAN	IMT (3GPP Band 28)	5 MHz	Digital Disturbance Recording, Distribution Network Automation, Substation Automation, AMI, SCADA, Operational Voice and Data, Video Monitoring
902-907.5/ 915-928 MHz	License Exempt	SRD	FAN	RF Mesh Networks	50, 200, 250 kHz	Distribution Automation, SCADA and AMI

<b>Spectrum bands</b>	<b>Spectrum assignment method used (auction, direct assignment, etc.)</b>	<b>Radiocomm. service (FS, MS, FSS, etc.)</b>	<b>Communications system architecture</b>	<b>Technologies or Technical Characteristics</b>	<b>Channel bandwidth</b>	<b>Utility applications supported by the communications systems</b>
1 487-1 517 MHz	Direct Assignment	FS	FAN	PTP – PMP Radio	5 MHz	Digital Disturbance Recording, Distribution Network Automation, Substation Automation, AMI, SCADA, Operational Voice and Data, Video Monitoring
2 025-2 110 MHz	Direct Assignment	FS, MS	FAN	PTP Radio	14 MHz	Digital Disturbance Recording, Distribution Network Automation, Substation Automation, AMI, SCADA, Operational Voice and Data, Video Monitoring
2 390-2 400 MHz	Direct Assignment	FS, MS	FAN	IMT (3GPP Band 40)	5 MHz	Digital Disturbance Recording, Network Automation, Substation Automation, AMI, SCADA, Operational Voice and Data, Video Monitoring
2 485-2 495 MHz	Direct Assignment	FS, MS	FAN	IMT (3GPP Band 53)	5 MHz	Digital Disturbance Recording, Network Automation, Substation Automation, AMI, SCADA, Operational Voice and Data, Video Monitoring
3 700-3 800 MHz	Direct Assignment	FS, MS	FAN	IMT-2020 (3GPP Band n78) / Low Power Radio	10 MHz	Digital Disturbance Recording, Network Automation, Substation Automation, AMI, SCADA, Operational Voice and Data, Video Monitoring
4 400-5 000 MHz	Direct Assignment	FS	WAN	PTP Microwave Radio	40 MHz	Digital Disturbance Recording, Network Automation, Power Plant and Substation Automation, AMI, SCADA, Operational Voice and Data, Video Monitoring, Protection
6 430-7 110 MHz	Direct Assignment	FS	WAN	PTP Microwave Radio	10 MHz	Digital Disturbance Recording, Network Automation, Power Plant and Substation Automation, AMI, SCADA, Operational Voice and Data, Video Monitoring, Protection

<b>Spectrum bands</b>	<b>Spectrum assignment method used (auction, direct assignment, etc.)</b>	<b>Radiocomm. service (FS, MS, FSS, etc.)</b>	<b>Communications system architecture</b>	<b>Technologies or Technical Characteristics</b>	<b>Channel bandwidth</b>	<b>Utility applications supported by the communications systems</b>
8 GHz	Direct Assignment	FS	WAN	PTP Microwave Radio	14 MHz	Digital Disturbance Recording, Network Automation, Power Plant and Substation Automation, AMI, SCADA, Operational Voice and Data, Video Monitoring, Protection
10.15-10.30 GHz	Direct Assignment	FS	WAN	PTP Microwave Radio	3.5 MHz	Digital Disturbance Recording, Network Automation, Power Plant and Substation Automation, AMI, SCADA, Operational Voice and Data, Video Monitoring, Protection
10.50-10.65 GHz	Direct Assignment	FS	WAN	PTP Microwave Radio	3.5 MHz	Digital Disturbance Recording, Network Automation, Power Plant and Substation Automation, AMI, SCADA, Operational Voice and Data, Video Monitoring, Protection
12.70-13.25 GHz	Direct Assignment	FS	WAN	PTP Microwave Radio	28 MHz	Digital Disturbance Recording, Network Automation, Power Plant and Substation Automation, AMI, SCADA, Operational Voice and Data, Video Monitoring, Protection
17.70-18.14 / 19.26-19.70 GHz	Direct Assignment	FS	WAN	PTP Microwave Radio	13.75 MHz	Digital Disturbance Recording, Network Automation, Power Plant and Substation Automation, AMI, SCADA, Operational Voice and Data, Video Monitoring, Protection
27.5-27.9 GHz	Direct Assignment	FS, MS	FAN	IMT-2020 (3GPP Band n261) / Low Power Radio	50 MHz	Digital Disturbance Recording, Network Automation, Power Plant and Substation Automation, AMI, SCADA, Operational Voice and Data, Video Monitoring, Protection



## 2 China

In China, part of the band 223-235 MHz was used for wireless smart grid applications. The band provides good propagation characteristics suitable to meet the wide area coverage requirement of many smart grid applications.

In China, both SWIN system (230 MHz discrete multi-carrier power wireless communication system: Smart and Wide-Coverage Industry-Oriented Wireless Network) and IoT-G 230 system (230 MHz discrete multi-carrier electric wireless communication system: IoT-G 230), have been used to achieve broadband transmission by aggregating multiple 25 kHz discrete carriers at part of the 223-235 MHz range (also referred here as band 230 MHz) to provide wireless service for smart grid. The 230 MHz spectrum provides good propagation characteristics suitable to meet the wide area coverage requirement of many smart grid applications.

## Summary of the technical characteristics of private utility radiocommunications in China

Spectrum bands	Spectrum assignment method used (auction, direct assignment, etc.)	Radiocomm. service (FS, MS, FSS, etc.)	Communications system architecture	Technologies or technical characteristics	Channel bandwidth	Utility applications supported by the communications systems
Part of 223-235 MHz	Direct Assignment	MS	WAN	<ul style="list-style-type: none"> <li>• Duplex Mode: TDD</li> <li>• Bandwidth and Scalability: 25 kHz × N (N=1 ~ 278) Carrier Aggregation.</li> <li>• Spectral efficiency: uplink peak spectral efficiency 2.9 bit/s/Hz, downlink peak spectral efficiency 2.2 bit/s/Hz.</li> </ul>	25 kHz	Wireless Smart Grid Applications

### 3 Ireland

#### 3.1 Case study – Spectrum for the Smart Grid

The Commission for Communications Regulation (ComReg) is the statutory body responsible for the regulation of the electronic communications sector (telecommunications, radio communications, broadcasting transmission, and premium rate services) and the postal sector in Ireland.

This case study will examine why the rights of use in the 400 MHz Band were subsequently awarded by ComReg on a technology neutral but service specific basis for the use of Smart Grids in Ireland, and how this decision was reached.

#### 3.2 Policy Issues and Objectives

ComReg consulted publicly [1] and explored, at a high level, possible uses for the 400 MHz Band and how it might be assigned. To assist, ComReg commissioned DotEcon [2] and Plum Consulting [3] to analyse the 400 MHz Band with a view to identifying possible uses, assessing how much spectrum may be needed for those uses, and to assess possible technical requirements.

Among other things, Plum assessed four broad categories of potential uses for the 400 MHz Band: Private/Professional Mobile Radio (“PMR”), Public Protection and Disaster Relief, Smart Meters, and Smart Grids. For each identified use, Plum assessed several factors including:

- a) The applicable technology(s) and future availability;
- b) The minimum spectrum block requirements; and
- c) The availability of alternative frequency bands and/or solutions

In relation to point (c), Plum discerned that PMR had alternative frequencies and consolidations available which could be used to deliver those services. However, Plum outlined that there were no alternative spectrum rights of use sufficient to provide for Smart Grid, noting principally that sub 1 GHz spectrum is required to connect to sub-stations, pumping stations, alternative energy sources and to achieve necessary geographic coverage over remote rural locations. It was deemed that the only alternative suitable spectrum for Smart Grid was the 450-470 MHz band, which at the time was assigned for and used extensively by PMR (Business Radio).

ComReg agreed with Plum and remained of the view that no suitable alternative spectrum was available for Smart Grid use. In addition, ComReg is of the view that Smart Grids are an intrinsic component of government efforts to meet the demand for energy in a cost effective and secure way, whilst also reducing the environmental impact. Using new technology, a Smart Grid could result in substantial reductions in energy use and carbon emissions and could make renewable energy and efficiency programs more affordable and accessible. Greater integration of renewable energies into electricity and gas grids is pivotal to lowering the environmental impact and meeting climate change targets:

- The ITU has outlined how smart grids can help to mitigate climate change by building more controllable and efficient energy systems [4]; and
- The UN has outlined that climate change requires development of Smart Grids founded on communications networks that can deliver centralised real-time monitoring and control, eventually across the entire power distribution domain (UNECE, 2015) [5].

ComReg’s final view was that a Smart Grid was likely to be required to meet various national and international policy goals and was likely to be a viable proposition in the period up to the end of the licence.

### 3.3 What is required to deliver a Smart Grid?

Plum identified several technical requirements for the effective use of Smart Grids:

- 1 Low to medium data rate typically 9.6 kbit/s to approximately 64 kbit/s, and up to multiple Mbit/s if video is required to monitor key installations;
- 2 Grid networks are expected to be deployed for a significant time (e.g.: 10 to 20 years);
- 3 Low jitter and synchronous requirements;
- 4 Enhanced resilience – for example this requires battery-power backup, which far exceeds that which is provided over MNO networks;
- 5 Instant and guaranteed channel access;
- 6 Extensive geographic coverage (including less populated areas to provide 100% coverage of the utility network);
- 7 Stringent latency requirements; and
- 8 High levels of security.

ComReg's final view, in light of the views of Plum, and the international recommendations of the European Telecommunications Standards Institute (ETSI) ETSI TR 103 401 [6], was that  $2 \times 3$  MHz of contiguous spectrum in the 400 MHz Band was required to provide a Smart Grid in Ireland.

ComReg was of the view that there were two possible alternatives for providing a Smart Grid: *a*) existing telemetry systems; or *b*) existing mobile networks. ComReg assessed each possible alternative against the technical requirements set out by Plum and CEPT and discounted both these options as follows.

First, the number of remote rural links is predicted to increase by between ten-fold and twelve-fold to and telemetry systems are unlikely to have enough bandwidth or spectrum to support an increase of such magnitude.

Secondly while certain aspects of a Smart Grid could be supported on a mobile network, there was a strong rationale for a dedicated network because:

- Mobile networks may not be able to meet the availability and reliability requirements – they may fail when the mains power fails, which is precisely when Smart Grid networks are most needed;
- Mobile networks may not have coverage in areas where Smart Grid elements such as remote sub-stations and wind farms are located, and operators may have little incentive to provide such coverage;
- Despite new concepts such as network slicing, mobile networks may have insufficient capacity or there may not be a clear business model to give the appropriate prioritisation to Smart Grid control messages; and
- The benefits of using commercial networks are smaller for Smart Grids than public safety as there is little need for handsets which benefit substantially for commercial economies of scale.

In terms of assigning spectrum ComReg considered that the following three regulatory options were available to it:

- 1 Assign all rights of use to the 400 MHz Band on a service and technology neutral basis.
- 2 Limit all rights of use to the 400 MHz Band for the provision of Smart Grid.
- 3 Limit some rights of use for the provision of Smart Grid and the remainder on a service and technology neutral basis.

To proceed with its decision-making, ComReg had to identify its stakeholders and the impact that the final decision would have on them. Network Utility Operators, MNOs, and other operators/users (PMR users, PPDR and Smart Metering) were identified as the primary stakeholders. After assessing the stakeholder impact, ComReg also had to assess the impact on competition and impact on consumers.

This assessment considered the likely impact of all valid regulatory options from the perspective of industry stakeholders and considered the likely impacts of all options on competition and consumers.

### 3.4 Preferred option

ComReg considered that, while Options 1 and 2 might be in the best interests of particular stakeholders, neither was likely to be preferable to Option 3 in terms of promoting competition. Thus, in this case, Option 3 appeared to be the best means to promote competition for spectrum usage rights and, in turn, promote competition in the related markets.

ComReg's final view was that Option 3 (to limit some rights of use ( $2 \times 3$  MHz) for the provision of Smart Grid and award the remainder on a service and technology neutral basis) was its preferred option.

ComReg considered its 'Preferred option' to be justified and proportionate for the following reasons:

- There is likely a key requirement for Smart Grid as evidenced by the various national and international policy targets to reduce carbon emissions and make the energy system more secure and sustainable, all of which include the provision of Smart Grids;
- Suitable and sufficient alternative spectrum rights of use are not readily available in other bands;
- A service and technology neutral award could result in the assignment of rights of use to other uses, foreclosing spectrum rights of use for the provision of Smart Grid;
- The proposed restriction would only relate to the spectrum rights of use necessary to efficiently operate a Smart Grid (i.e.:  $2 \times 3$  MHz). The remaining  $2 \times 1$  MHz would be made available on a service and technology neutral basis.
- The views of DotEcon that this band is the only opportunity in the foreseeable future to establish a wireless Smart Grid network in Ireland.

### 3.5 The Award of 400 MHz Rights of Use

In August 2019, based on its preferred option, ComReg launched the spectrum award [7] and offered new spectrum rights of use in two parts. Part A consisted of one  $2 \times 3$  MHz Lot (410-413 MHz / 420-423 MHz) for the provision of wireless communications for Smart Grids, and Part B consisted of ten lots of  $2 \times 100$  kHz on a technology and service neutral basis. It was noted that the Lots in Part B may be used to support Smart Grid, or for a range of other uses including Business Radio type applications.

On 5 November 2019, ComReg published the results of the 400 MHz band spectrum award (Smart Grid) in Information Notice [8]. The Award Process resulted in 1 Winning Bidder, ESB Networks Ltd, that was issued with a 15-year licence.

ESB Networks Ltd (ESBN) [9], a regulated subsidiary within the ESB Group [10], is the licensed operator of the electricity distribution system in the Republic of Ireland. ESBN is responsible for building, operating, maintaining, and developing the electricity network and serving all electricity customers in the Republic of Ireland. The electricity distribution network includes all distribution stations, overhead electricity lines, poles and underground cables used to bring power to more than 2 million domestic, commercial, and industrial customers connected to the electricity network

nationwide. ESB Networks is currently in a procurement process to acquire equipment and services to deploy a purpose built nationwide Smart Grid network.

### 3.6 References

- [1] ComReg Document 17/67 – Consultation on Proposed Release of the 410-415.5 / 420-425.5 MHz Sub-band. Published 31<sup>st</sup> July 2017.
- [2] ComReg Document 18/92a – DotEcon Limited on the Award of Licences for the use of Radio Frequencies in the 400 MHz Band, A report for Comreg. Published 24<sup>th</sup> October 2018. [www.dotecon.com](http://www.dotecon.com)
- [3] ComReg Document 18/92b – Plum Consulting on the Potential use of the 400 MHz band in Ireland, A report for ComReg. Published 24<sup>th</sup> October 2018. [www.plumconsulting.co.uk](http://www.plumconsulting.co.uk)
- [4] <https://news.itu.int/energy-efficiency-fight-climate-change-vital-role-icts/>
- [5] United Nations Economic Commission for Europe, Electricity Systems Development – A Focus on Smart Grids, August 2015.
- [6] ETSI, ‘Smart Grid Systems and Other Radio Systems suitable for Utility Operations, and their long-term spectrum requirements’, November 2016. ETSI TR 103 401 V1.1.1 (2016-11).
- [7] ComReg Document 19/80 – 400 MHz Band Spectrum Award – Information Memorandum. Published 30 August 2019.
- [8] ComReg Document 19/99 – Results of the 400 MHz Band Spectrum Award. Published 5<sup>th</sup> November 2019.
- [9] <https://www.esbnetworks.ie/>
- [10] <https://www.esb.ie/>

## Summary of the technical characteristics of private utility radiocommunications in Ireland

Spectrum bands	Spectrum assignment method used (auction, direct assignment, etc.)	Radiocomm. service (FS, MS, FSS, etc.)	Communications system architecture	Technologies or technical characteristics	Channel bandwidth	Utility applications supported by the communications systems
410-414 MHz / 420-424 MHz	Auction and Award	FS, MS	WAN	<ul style="list-style-type: none"> <li>• National LTE Network (15 000-50 000 CPEs)</li> <li>• 3 MHz FDD channel</li> <li>• LTE-M upgrade to use additional 1 MHz FDD spectrum</li> </ul>	3 MHz FDD + 1 MHz FDD	Full connectivity of CPE below 38 kV with a Smart Grid

#### 4 Republic of Korea

In Republic of Korea, frequency band 380-400 MHz with 25 kHz of channel spacing has been allocated for private mobile radio for business purpose based on licence and this band is also available for utilities. Approximately 50+ channel pairs of 382-385 MHz (UL) and 392-395 MHz (DL) have been assigned for controlling electric power distribution. 140 base stations have been deployed for this nationwide radio system, and distribution automation and automatic remote metering are utilized. This was a change from analogue radio system using 800 MHz band to digital radio system using 380 MHz band.

The digital trunked radio system provides better performance than the old analogue trunked radio system: shorter controlling time and more event handling. The 380 MHz band provides longer propagation characteristics suitable to meet the wide area coverage requirement.

In 2021, 4.72-4.82 GHz and 28.9-29.5 GHz frequency bands were allocated for private 5G networks for business purpose. 4.72-4.82 GHz is divided into 10 blocks of 10 MHz bandwidths, and 28.9-29.5 GHz is divided into 12 blocks of 50 MHz bandwidths for assignment.

The national electric power corporation is also adding a 5G network for digital transformation including IoT, robotics and smart office. IoT will be used for collection and analysis of real-time data from power facilities. Robotics will be applied to substations so that automation of tasks will be tried including autonomous movement for getting status of power facilities and analysis. And by implementing a smart office environment for work anytime and anywhere, maximization of manpower resources is expected.

The nationwide mobile broadband PPDR network (so called Safe-Net) has been implemented in 2021, and the agencies related with electric and gas have been categorized in the 8 major user agency groups together with police, fire, coast guard, military, emergency medical service, and government administration. Therefore, the field personnel related with electric and gas are using the network for voice, data and video communications for their daily checking and disaster management. 718-728 MHz (UL) and 773-783 MHz (DL) frequency band have been assigned for this government radio network.

For gas and water, public mobile networks are also used. Gas and electric are adding Advanced Metering Infrastructure and the traditional mechanical metering is replaced by smart gas meter for improving gas management. Water is replacing their wireline communication systems with radio communication systems and expecting improving the management and cost saving.



## Summary of the technical characteristics of private utility radiocommunications in the Republic of Korea

Spectrum bands	Spectrum assignment method used (auction, direct assignment, etc.)	Radiocomm. service (FS, MS, FSS, etc.)	Communications system architecture	Technologies or technical characteristics	Channel bandwidth	Utility applications supported by the communications systems
380-385 paired with 390-395 MHz	Direct assignment	MS	WAN	TETRA	25 kHz	Electric - Distribution automation, remote metering
718-728 paired with 773-783 MHz	Direct assignment	MS	WAN	PS-LTE	10 MHz	Electric and gas - Voice, data and video communication
4.72-4.82 GHz	Direct assignment	MS	WAN	5G	10 MHz	Electric - Digital transformation
28.9-29.5 GHz	Direct assignment	MS	WAN	5G	50 MHz	Electric - Digital transformation

## 5 United Kingdom of Great Britain and Northern Ireland

### 5.1 Utility spectrum management

To enable the diverse needs of all utilities (electricity, gas and water) in the UK to be met, a range of spectrum options were made available by the UK Regulatory Authority, Ofcom in VHF and UHF spectrum<sup>29</sup> to support a variety of applications used by the Utilities sector.

The Joint Radio Company Ltd (JRC) undertakes the task of co-ordination and allocation of these frequencies for narrowband services for the energy sector (electricity and gas industries), and there is a similar arrangement by the Telecommunications Association of the UK Water Industry (TAUWI) for the water industries.

### 5.2 Utility spectrum access

Utilities in the UK have access to and use a diverse range of frequencies to address their operational telecommunication requirements:

- VHF low band channels, around 80 MHz for voice PMR, mainly the water sector
- Approximately  $2 \times 1$  MHz of 12.5 kHz channelised spectrum in VHF mid-band in the 150 MHz region for emergency trunked voice communications and low data rate traffic (usually 9.6 kbit/s), mainly for the electricity sector.
- $2 \times 1$  MHz of spectrum in the VHF midband region of 150 MHz channelised at 12.5 kHz and used for automation by the electricity industry with data rates in the region of 8 kbit/s.
- A few 12.5 kHz VHF High Band channels for handheld voice communications.
- A dedicated block of  $2 \times 1$  MHz of spectrum in UHF2 (450-470 MHz) for point-to-multi-point SCADA fixed communications, based on 12.5 kHz channelisation with data rates of up to 80 kbit/s.
- Small amounts of spectrum throughout the 400 MHz frequency range of the UHF band for voice and data communications in channel bandwidths of up to 25 kHz with data rates up to 128 kbit/s.
- Licence-exempt spectrum for telemetry use shared with other sectors in VHF and UHF bands.
- Publicly licensed spectrum bands for microwave links and satellite services.
- $2 \times 20$  MHz of private spectrum at 10.5 GHz.

The private radio services are used in conjunction with public radio services – mainly the public mobile network operators (MNOs) together with limited access to the Emergency Services Airwave Tetra Service for resilient voice communications.

### 5.3 Future utilities needs

The UK energy industry anticipates that energy networks will transition over the next few decades from a relatively small number of large power stations to an increasingly distributed structure

---

<sup>29</sup> 139.5-140.5 MHz paired with 148.0-149.0 MHz

169.050 MHz simplex

443.150-443.375 MHz paired with 428.650-428.875 MHz

456.0625-456.3125 MHz paired with 461.5625-461.8125 MHz

457.5-458.5 MHz paired with 463.0-464.0 MHz.

comprising thousands of embedded energy sources including wind turbines and solar generation, complemented by battery storage. It is anticipated that the distributed nature of future energy generation will result in increased scale and importance of operational communications to ensure the operational integrity of the system. In particular, there will be a need for more real time monitoring, control and automation with specific performance, security and resilience requirements. In the water industry, improving monitoring and control of water flows and leaks should help better manage flood and drought risks.

Ofcom are assessing the implications of these changes in utilities communications needs for future spectrum demand.

### Summary of the technical characteristics of private utility radiocommunications in the United Kingdom

Spectrum bands	Spectrum assignment method used (auction, direct assignment, etc.)	Radiocomm. service (FS, MS, FSS, etc.)	Communications system architecture	Technologies or technical characteristics	Channel bandwidth	Utility applications supported by the communications systems
80 MHz	Assignment	MS	WAN	EN 300 113	12.5 kHz	Voice PMR, mainly the water sector
139.5-140.5 MHz paired with 148.0-149.0 MHz	Assignment	MS	WAN	EN 300 113	12.5 kHz	Emergency trunked voice communications and low data rate traffic (usually 9.6 kbit/s), mainly for the electricity sector
143-144 MHz paired with 154-155 MHz	Assignment	MS	WAN	DMR	12.5 kHz	Automation by the electricity industry with data rates in the region of 8 kbit/s
169.050 MHz simplex	Assignment	MS	FAN	EN 300 113	12.5 kHz	Hand-held voice communications
443.150-443.375 MHz paired with 428.650-428.875 MHz	Assignment	MS	FAN	EN 300 113 or DMR	12.5 kHz	Variety of applications used by the Utilities sector
450-470 MHz	Allocation	FS	WAN	OfW49	12.5 kHz	Point-to-multi-point SCADA fixed communications with data rates up to 80 kbit/s
400 MHz	Assignment	MS and FS	Varied	DMR or EN 300 113	12.5 kHz or 25 kHz	Voice and data communications with data rates up to 128 kbit/s
10.5 GHz	Auction	FS	ETSI	ERC/REC 12-05	2 × 20 MHz	Point-to-point and point-to-multipoint backhaul and SCADA aggregation.
380-385 MHz paired with 390-395 MHz	Allocation	MS	WAN	Tetra	25 kHz	Limited access to the Emergency Airwave Service for resilient voice communications.

## 6 France

### 6.1 Utility spectrum management

To enable the diverse needs of the energy utilities in France to be met, a range of spectrum options have been made available.

Utilities need telecommunications services that are:

- Reliable
- Secure
- Cost effective
- Resilient.

When utility requirements are close to the target audience of the telcos, it's an easy choice, but when additional requirements are added for mission critical services, e.g.:

- Coverage (important RTUs even in remote areas)
- Latency (for safety reasons)
- Security (physical separation of critical data)
- Resilience (to escape the vicious circle “no electricity/no telecommunications”).

Then utilities may have to resort to using a private network. Even if some utilities can deploy fibre optic networks, the cost-effectiveness and coverage requirements tips the scales in favour of wireless communications which need access to suitable and sufficient radio spectrum.

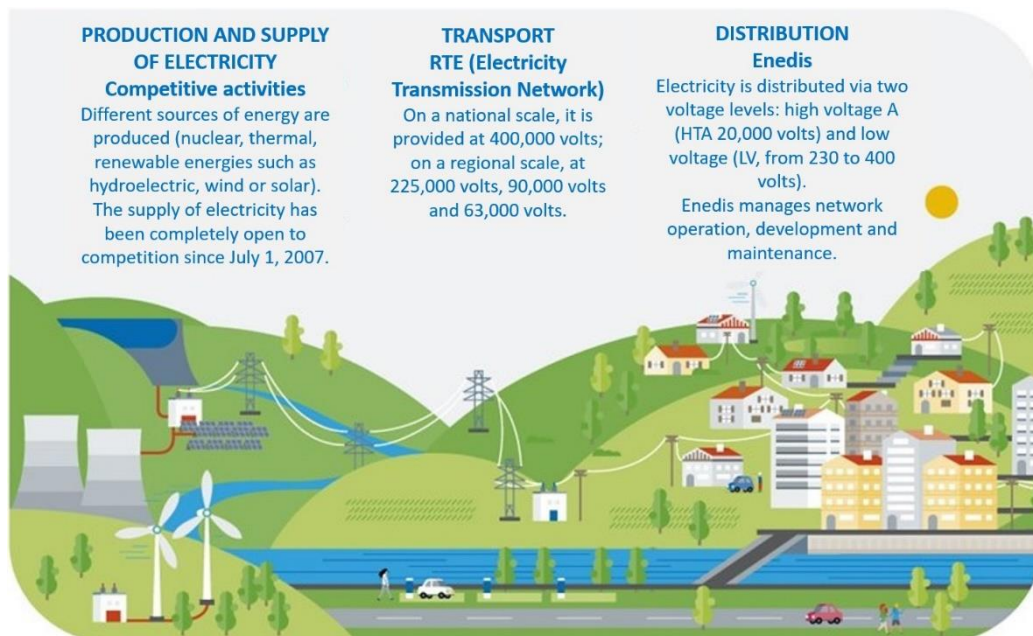

### 6.2 Transmission

The electricity transmission network in France is owned and operated by the public utility *Réseau de Transport d'Électricité* (RTE). RTE maintains and expands the capacity of the high and ultra-high voltage grid (ranging from 63 000 to 400 000 volts) amounting to over 100 000 kilometres of overhead lines, over 6 000 kilometres of underground lines, 2 800 solely operated or jointly operated substations and 51 cross-border lines. France's power grid is interconnected with 33 countries. As a

key industrial player in the energy transition, RTE is optimising and transforming its grid with a view to accommodating more power generation facilities, irrespective of future energy choices.

Most of RTE's communications are carried on fibreoptic cables, although where suitable fibre routes do not exist, or for redundancy, radio links are used, especially for teleprotection.

### 6.3 Generation

The majority of electricity in France is generated by *Électricité de France* (EDF), a multinational electric utility company owned by the French state. EDF operates a diverse portfolio of at least 120 gigawatts of generation capacity in Europe, South America, North America, Asia, the Middle East, and Africa. Its 56 active nuclear reactors (in France) are spread out over 18 sites. EDF is also involved in hydropower production, wind generation and solar generation in France.

The bulk of EDF's telecommunications needs are met by fibreoptic communications. However, power stations are large industrial sites and require radiocommunications for safety and operational purposes. EDF is deploying 3GPP technologies for this purpose in nuclear power plants and is undertaking a number of trials in another sector. At present, EDF is borrowing sub-GHz spectrum in the 700 MHz band and also uses a private radio network in the 2.6 GHz band to ensure communications resilience so that the essential operational characteristics of the communications network are maintained at all times in the nuclear power plant.

### 6.4 Distribution

The main operator of the public electricity distribution network in France is Enedis. More specifically, Enedis manages the low and medium voltage network over 95% of French territory. Enedis owns and operates 1.4 million km of lines:

Enedis has 37.5 million customers within an operational area of more than 500 000 km<sup>2</sup>. To service this requirement, Enedis operates a private 70 MHz radio network (with a large number of microwave links for backhaul). The use of this critical operational network is to escape the "No electricity/no telecommunications" vicious circle. As well as Private Mobile Radio (PMR), this network also supports the control/command of more than 20 000 legacy Remote Terminal Units (RTU).

Because of the age of this network, Enedis are studying the opportunity to access to a new private network. The rationale for this approach is:

- For use cases needing large coverage (rural areas...)
- For mission critical devices (availability, QoS...)

For other non-critical uses cases, licence-exempt short-range devices (SRD) are used today, but for the future, Enedis is eager to deploy 3GPP based technology either in collaboration with public mobile operators or if needed by deployment of a private network. This is because:

- The 70 MHz PMR network cannot accommodate all new devices/RTUs because:
  - IP based protocols are:
    - More verbose
    - Vulnerable to cyber-attacks, hence remote administration is required
  - New smart grid operations are more demanding, requiring:
    - Always connected
    - Continuous flows of data
    - Many more points of connectivity

## 6.5 Smart meters

France is committed to a nationwide rollout of smart meter. The chosen technology has been named 'Linky' and uses powerline carrier (PLC) technology. Data is concentrated at terminals which transfer it to a central information system using public mobile telecommunications networks.

## 6.6 Future spectrum options for utilities

France is examining a number of options to meet the future needs of utilities for spectrum access to address growing smart grid requirements and sustainability obligations:

- 2.6 GHz band (2 blocks of 20 MHz) is open for local coverage 4G connectivity.
- Future use of 3.8-4.2 GHz band by terrestrial wireless broadband systems providing local area low/medium power network connectivity using 5G.
- New bands at 26 GHz and 42 GHz.
- Various options for introducing wideband services in the frequency band 450-470 MHz or 470-694 MHz as being requested by several large private network operators for IMT-2020 type technologies to cover the larger geographic areas and adding IoT technologies unsuitable for coverage at higher frequencies.

## Summary of the technical characteristics of private utility radiocommunications in France

<b>Spectrum bands</b>	<b>Spectrum assignment method used (auction, direct assignment, etc.)</b>	<b>Radiocomm. service (FS, MS, FSS, etc.)</b>	<b>Communications system architecture</b>	<b>Technologies or technical characteristics</b>	<b>Channel bandwidth</b>	<b>Utility applications supported by the communications systems</b>
70 MHz	Direct assignment	MS	WAN	DMR	12.5 kHz	Wide-area PMR network for voice communications and controls
2.6 GHz	Shared	MS	FAN	LTE	20 MHz	Large area site communications, typically nuclear and hydroelectric power stations
3.8-4.2 GHz	Administrative allocation	MS	MAN	5G	10-100 MHz	Wireless broadband systems providing local area low/medium power network connectivity



## Annex 7

### Relevant ITU-R and ITU-T Resolutions, Recommendations, Reports and Handbooks

#### ITU-R Resolutions

Resolution [ITU-R 60](#) – *Reduction of energy consumption for environmental protection and mitigating climate change by use of ICT/radiocommunication technologies and systems*

#### ITU-R Recommendations

[ITU-R F.592-4](#) – *Vocabulary of terms for the Fixed Service*

[ITU-R F.701](#) – *Radio-frequency channel arrangements for digital point-to-multipoint radio systems operating in the frequency range 1 350 to 2 690 MHz*

[ITU-R F.755](#) – *Point-to-Multipoint Systems in the Fixed Service.*

#### ITU-R Reports

[ITU-R M.2014](#) – *Digital Land Mobile Systems for dispatch traffic*

[ITU-R SM.2351](#) – *Smart grid utility management systems*

[ITU-R M.2440](#) – *The use of the terrestrial component of International Mobile Telecommunications (IMT) for Narrowband and Broadband Machine Type Communications*

[ITU-R M.2441](#) – *Emerging usage of the terrestrial component of International Mobile Telecommunication (IMT)*

[ITU-R M.2474](#) – *Conventional digital land mobile radio systems*

Working document towards a preliminary draft new Report ITU-R M.[IMT.INDUSTRY] – *Applications of IMT for specific societal, industrial and enterprise usages* (See Doc. [5D/1078](#) (Annex 3.3).

#### ITU-R Handbooks

[Land Mobile \(including Wireless Access\) - Volume 1](#): Fixed Wireless Access

[Land Mobile \(including Wireless Access\) - Volume 3](#): Dispatch and Advanced Messaging Systems.

#### ITU-T Recommendations

[ITU-T G.9960](#) – *Unified high-speed wireline-based home networking transceivers – System architecture and physical layer specification*

[ITU-T G.9961](#) – *Unified high-speed wire-line based home networking transceivers – Data link layer specification*

[ITU-T L.1390](#) – *Energy saving technologies and best practices for 5G radio access network (RAN) equipment*

[ITU-T Y.2072](#) – *Framework for an energy-sharing and trading platform*

[ITU-T Y.4093](#) – *Key performance indicators for smart sustainable cities to assess the achievement of sustainable development goals.*

#### ITU-T Technical Paper

[GSTP-HNSG](#): Technical paper on the use of G.hn technology for smart grid.

## List of definitions, acronyms and abbreviations

### Definitions

<b>Smart Grid</b>	The “Smart Grid” is a two-way electric power delivery network connected to an information and control network through sensors and control devices. This supports the intelligent and efficient optimization of the power network.
<b>Demand response</b>	A smart grid feature that allows consumers to reduce or change their electrical use patterns during peak demand or when power reliability is at risk: usually in exchange for a financial incentive: demand response is necessary for optimizing the balance of power supply and demand.
<b>Advanced energy measurement</b>	Technology to electronically measure energy consumption, allowing consumers to interact with the supply system (active participation in managing electricity).
<b>Electrical grid automation</b>	Algorithms and methods that allow the optimization and automatic restoration of power after power outages or load redistributions
<b>Alternative renewable energy sources</b>	Technology to generate electric energy using natural sources such as the sun, the wind and geothermal energy, which are alternative renewable (naturally replenished) resources.
<b>Energy efficiency</b>	The ratio or other quantitative relationship between an output of performance, service, goods or energy, and an input of energy.
<b>Power quality</b>	Monitoring and evaluating electrical parameters of energy networks to characterize the quality of the service and of the distributed energy
<b>IEC 61850</b>	Communication networks and systems for power utility automation.
<b>Monitoring of the electrical infrastructure and equipment</b>	Methods, sensors and algorithms used to monitor electrical equipment parameters to evaluate the operating conditions and useful life of assets
<b>Distributed Generation</b>	Generation of electricity located close to the load (or consumers) they serve, typically using renewable energy sources.
<b>Information and Communications Technology (ICT) Networks</b>	Telecommunications networks that carry data, video, and other services. Utilities provision these networks to underpin their transmission and distribution infrastructure for daily reliability needs, situational awareness, grid modernization, cyber and physical protection, Supervisory Control and Data Acquisition (SCADA) communications, storm response and recovery, and much more.
<b>Mission Critical Applications</b>	An application is mission-critical when it is essential to operation: thus, mission-critical applications should not experience any downtime when end users are likely to utilize them.
<b>Business Critical Applications</b>	An application is business-critical when it is essential to business operation. Business-critical applications should not experience significant downtime and are expected to be available all time, resilient, redundant and secure.
<b>Supervisory Control and Data Acquisition (SCADA) System</b>	SCADA performs automatic monitoring, protecting and controlling of various equipment in distribution systems with use of intelligent electronic devices (or RTUs), restoring the power service during fault conditions and it also maintains the desired operating conditions as well as improving the reliability of supply by reducing duration of outages while providing cost-effective operations of the distribution system.
<b>Resilient Communications</b>	The ability of a utility’s ICT network to prepare for, withstand, and recover from natural or manmade disasters. Utility ICT networks are essential for daily reliability along with the ability to safely restore service after an event. These networks are intended to be, and are, more reliable than those operated by traditional telecommunications providers.
<b>Synchrophasors</b>	Sensors and algorithms to provide additional information currently not available via standard SCADA installation allowing to operate the bulk electric system more efficiently
<b>Utility</b>	An entity providing services such electricity, gas, water and heating to the general public and/or to industrial and commercial entities.
<b>Utility Radiocommunications</b>	Wireless systems used by utilities for voice and data communications to support their electricity, water or gas operations

**Acronyms**

<b>Abbreviation</b>	<b>Definition</b>
3GPP	The 3rd Generation Partnership Project
ADR	Automated demand response
AI	Artificial intelligence
AMI	Advanced metering infrastructure
AR	Access router
BAN	Building area network
bit/s	Bits per second
BR	Backbone router
C&I	Commercial and Industrial
CCTV	Closed Circuit TV
CDMA	Code division multiple access
CEPT	European Conference of Postal and Telecommunications Administrations
CIP	Critical infrastructure protection
CNI	Critical national infrastructure
DA	Distribution automation
DCC	Distribution Control Centre
DDR	Digital disturbance recorder
DG	Distributed generation
DLR	Dynamic line rating
DMS	Distribution Management System
DNO	Distribution network operator
DNP	Data network protocol
DR	Demand response
DS	Distributed storage
DSO	Distribution system operator
ECC	Electronic Communications Committee
EI	Edison Electric Institute
ER	Edge router
ETSI	European Telecommunications Standards Institute
EVCS	Electric vehicle charging station
FAN	Field area network
FCC	Federal Communications Commission
GPON	Gigabit passive optical network
GPS	Global Positioning System
HAN	Home area network
IAN	Industrial area network
IED	Intelligent electronic device
IEEE	Institute of Electrical and Electronics Engineers
ISM	Industrial, Scientific and Medical
ISO	International Organization for Standardization
LAN	Local area network
LTE	Long Term Evolution
MDMS	Meter data management system

<b>Abbreviation</b>	<b>Definition</b>
MWF	Mobile work force
NAN	Neighbourhood area network
NASPINet	North American Synchrophasor Initiative Network
NERC	North American Electric Reliability Corporation
PMU	Phasor measurement unit
PTT	Push-to-talk
RF	Radio frequency
RLAN	Radio local area network
RTU	Remote terminal unit
SCADA	Supervisory control and data acquisition
TDM	Time division multiplex
TSO	Transmission system operator
TSS	Transmission substations
UHF	Ultra-high frequency
VHF	Very high frequency
VoIP	Voice over Internet protocol
WAMPC	Wide area measurement protection and control

---